



**LT0345 SmartConfig LITE V2.9.0.0
User Manual**

Wednesday, 24 June 2020

LT0345 SmartConfig LITE V2.9.0.0

© 2020 ... Johnson Controls, All Rights Reserved.

SmartConfig is a Windows program for editing, viewing, and/or printing the configuration database for VIGILANT products manufactured by Johnson Controls, Christchurch.

Johnson Controls takes no responsibility for the use of this program or the operation of systems configured by its use. All installed systems must be fully tested to ensure that they meet the stated requirements of the customer and all relevant regulations, standards, and accepted trade practices.

Regular expression support is provided by the PCRE library package V2.01, which is open source software, written by Philip Hazel, and copyright 1998 by the University of Cambridge, England.

The Open Sans Condensed Light font is copyright © 2011, Google Corporation, and is licensed under the Apache License 2.0 as reproduced in the Disclaimer section of the LT0345 SmartConfig LITE V2.9.0.0 help file. Open Sans is a trademark of Google and may be registered in certain jurisdictions.

Table of Contents

| | |
|---|-----------|
| Part I Getting Started | 6 |
| Part II Menu Commands | 7 |
| 1 File | 7 |
| 2 Edit | 10 |
| 3 Select | 12 |
| 4 Profile | 12 |
| 5 View | 12 |
| 6 Check | 14 |
| 7 Window | 14 |
| 8 Tools | 15 |
| 9 Help | 15 |
| Part III General Reference | 16 |
| 1 General Editing Instructions | 16 |
| 2 Template Files | 18 |
| 3 Terminal Window | 18 |
| 4 Password Strength | 21 |
| Part IV FP1600 / Omega 64 System | 22 |
| 1 FP1600 Overview | 22 |
| 2 FP1600 Version Differences | 23 |
| 3 FP1600 Getting Started | 24 |
| 4 FP1600 Tables | 24 |
| Zones | 25 |
| Zone Map Ancil | 26 |
| Zone Map Groups | 26 |
| Zone Map Variables | 27 |
| Group Config | 28 |
| Group Map Ancil | 28 |
| Group Map Variables | 29 |
| Ancil Config | 29 |
| Ancil Map Variables | 30 |
| Variables Notes | 31 |
| System Config | 31 |
| Change Log | 32 |
| Comments | 32 |
| 5 Download / Upload | 32 |
| Communicating with the FP1600 Panel | 32 |
| 6 FP1600 Reference | 34 |

| | |
|---|-----------|
| Checks | 34 |
| Part V IO-NET | 35 |
| 1 Opening Files | 35 |
| 2 Parameters | 35 |
| Address | 36 |
| Max Stations | 36 |
| RZDU Number | 36 |
| TX Zone Data | 37 |
| RZDU Protocol | 37 |
| Allow reduced RAM | 38 |
| Off-line RAM Assumptions | 39 |
| 3 Output Logic | 39 |
| General Format | 39 |
| Operators | 41 |
| Order of evaluation | 42 |
| Operand Types | 43 |
| IO-NET Inputs..... | 44 |
| IO-NET Outputs..... | 44 |
| F3200 / MX4428 / MX1 Zone Data..... | 44 |
| Variables | 45 |
| New Alarm Function..... | 46 |
| System Conditions..... | 47 |
| Constants..... | 49 |
| Timers | 49 |
| 4 Change Log | 55 |
| 5 Notes | 55 |
| 6 Network Profiles | 55 |
| 7 Example Programs | 55 |
| Duplicating Non-Programmed mode | 55 |
| Passing Data onto the IO-NET network | 56 |
| Accessing Zones | 56 |
| 8 Checking a Program | 56 |
| 9 Programming an IO-NET Controller | 57 |
| 10 Extracting a program from an IO-NET Controller | 57 |
| Part VI T-Gen2 | 59 |
| 1 Overview | 59 |
| 2 Operation | 60 |
| 3 Audio Mapping | 61 |
| 4 High Priority Functions | 62 |
| 5 Getting Started | 63 |
| 6 Tables | 63 |
| General | 63 |
| Digital & HLL Inputs | 66 |
| Audio Inputs | 68 |
| GP Outputs | 69 |
| Messages | 69 |

| | |
|---|-----------|
| Signals | 70 |
| Strobe Sequences | 71 |
| Switching Modules | 71 |
| User Interface | 73 |
| T-Gen2s | 74 |
| PSE Slaves | 75 |
| Cascade | 75 |
| Area Mapping | 76 |
| Change Log | 76 |
| Instructions | 76 |
| 7 Strobe/Signal Builder | 77 |
| 8 Transfer DB to/from T-Gen2 | 79 |
| 9 Reset T-Gen2 to Defaults | 80 |
| 10 Checks | 81 |
| 11 Template Files | 82 |
| 12 Firmware Update | 84 |
| | |
| Part VII What's New | 86 |
| 1 Version 2.9.0 | 86 |
| 2 Version 2.8.0 | 86 |
| 3 Version 2.7.0 | 86 |
| | |
| Index | 87 |

1 Getting Started

Start with [File | New](#)^[7]. Select the type of system you want to configure. This will give you a blank database to configure. Alternatively open an existing database with [File | Open](#)^[7].

Select the table or form to edit from the listbox on the left. Tables with multiple entities (e.g. Zones) are normally viewed in [table view](#)^[16], while tables with only one entity (e.g. System) are normally viewed in [form view](#)^[17].

Row and column headings are in light grey. Cells you can edit are generally in white. Cells with calculated useful information are in light yellow. Cells that are not applicable are in dark grey. (These colours may vary depending on your Windows colour scheme.) Other cells are generally white, but various colours may be used by SmartConfig to highlight less frequent settings or grouped settings.

There are four basic types of cells -

1. Multichoice. These are displayed with a blue triangle on the right. Click the triangle to get the choices. In form view they may be displayed as a radio group or as a drop-down edit box.
2. Yes / No - displayed as a box with or without a tick
3. Integer
4. String

Refer to [General Editing Instructions](#)^[16] for additional general information.

Check the configuration. [Check | Check tables](#)^[14]

Save the completed configuration. [File | Save](#)^[8].

Refer also to the Getting Started or Overview section for the particular system type you are using.

2 Menu Commands

This shows the menu commands available in SmartConfig, and describes their function.

2.1 File

New

Creates a new database for the selected system type, and initialises it from the selected template file.

SmartConfig may be supplied with multiple template files for some panel types, and/or you can create your own templates. (See [Template Files](#) ^[18])

Open

Opens an existing file saved in SmartConfig format. Additionally, for some system types, you may be able to open a file in the file format able to be directly transferred to/from the panel (e.g. s28 format).

Whatever extension the file has, the file content will be examined so it will be opened and read correctly.

Merge

This command is intended for expert users. Some experimentation may be needed to get the effect required. Save the database first, as there is no "undo".

This merges a database file or template into the currently open database. Data in the file will overwrite, or be appended to, data in the current database as follows -

| Type of table in the file to be merged | What happens | | | | | | | | | | | | |
|--|---------------------|-------------------------------------|-------------|------------|---------------------|----------------------|-------------------------------------|---------------------|--------------------|---|-------------------------------------|-------------|--|
| <p>A table of profiles or more generally a table where each row is identified by a unique user supplied name. Example :</p> <table border="1"> <thead> <tr> <th>Profile Name</th> <th>Default for</th> <th>Lock</th> <th>Applies to</th> </tr> </thead> <tbody> <tr> <td>Type A AS1603.1</td> <td>814CH</td> <td><input checked="" type="checkbox"/></td> <td>814PH,814H,</td> </tr> <tr> <td>Type B AS1603.1</td> <td>Others</td> <td><input checked="" type="checkbox"/></td> <td>814PH,814H,</td> </tr> </tbody> </table> | Profile Name | Default for | Lock | Applies to | Type A AS1603.1 | 814CH | <input checked="" type="checkbox"/> | 814PH,814H, | Type B AS1603.1 | Others | <input checked="" type="checkbox"/> | 814PH,814H, | <p>Non-default data in the file to be merged overwrites existing settings in the row with the same unique identifier. If there is no row with a matching unique identifier, the row in the file to be merged will be appended to existing rows.</p> <p>In the example, data in the file to be merged will overwrite the original data in the row with the same profile name.</p> |
| Profile Name | Default for | Lock | Applies to | | | | | | | | | | |
| Type A AS1603.1 | 814CH | <input checked="" type="checkbox"/> | 814PH,814H, | | | | | | | | | | |
| Type B AS1603.1 | Others | <input checked="" type="checkbox"/> | 814PH,814H, | | | | | | | | | | |
| <p>A table with grey column(s) on the left. Example :</p> <table border="1"> <thead> <tr> <th>Zone No.</th> <th>Zone Type Profile</th> <th>Zone Name</th> </tr> </thead> <tbody> <tr> <td>1</td> <td>Std Detection G1</td> <td>Manual Call Point</td> </tr> <tr> <td>2</td> <td>Std Detection G1</td> <td>Ground Floor</td> </tr> </tbody> </table> | Zone No. | Zone Type Profile | Zone Name | 1 | Std Detection G1 | Manual Call Point | 2 | Std Detection G1 | Ground Floor | <p>Non-default data in the file to be merged overwrites existing settings in the row with the same values in the grey columns.</p> <p>In the example, data in the file to be merged will overwrite the original data for the same zone.</p> | | | |
| Zone No. | Zone Type Profile | Zone Name | | | | | | | | | | | |
| 1 | Std Detection G1 | Manual Call Point | | | | | | | | | | | |
| 2 | Std Detection G1 | Ground Floor | | | | | | | | | | | |

| <p>A table with no greyed columns or unique identifier column. Example :</p> <table border="1" data-bbox="156 286 655 539"> <thead> <tr> <th>Date</th> <th>Person</th> <th>Change Description</th> </tr> </thead> <tbody> <tr> <td>21/07/2009</td> <td>TSP</td> <td>MX1 Au Template V1.01</td> </tr> <tr> <td>30/7/2010</td> <td>KOV</td> <td>Customised for 131 High St</td> </tr> <tr> <td>1/8/2010</td> <td>KOV</td> <td>Added zone for roof</td> </tr> </tbody> </table> | Date | Person | Change Description | 21/07/2009 | TSP | MX1 Au Template V1.01 | 30/7/2010 | KOV | Customised for 131 High St | 1/8/2010 | KOV | Added zone for roof | <p>Each row in the file to be merged will be appended to any existing rows.</p> |
|--|--|----------------------------|--------------------|------------|-----|-----------------------|-----------|-----|----------------------------|----------|-----|---------------------|---|
| Date | Person | Change Description | | | | | | | | | | | |
| 21/07/2009 | TSP | MX1 Au Template V1.01 | | | | | | | | | | | |
| 30/7/2010 | KOV | Customised for 131 High St | | | | | | | | | | | |
| 1/8/2010 | KOV | Added zone for roof | | | | | | | | | | | |
| <p>Logic or other text page.</p> | <p>Lines of text in the file to be merged are added after the existing lines.</p> | | | | | | | | | | | | |
| <p>A table with only one row (that is normally shown in form view).</p> | <p>Non-default settings in the file to be merged will overwrite existing settings.</p> | | | | | | | | | | | | |

After selecting the file to be merged, a selection screen allows selection of which tables in the existing file are to be kept, and for the file to be merged in, what tables to include. Via these selections of keep existing tables and merging the new ones, a combination of old, new, and merged can be obtained.

It is likely that the result will need further editing to remove duplications, and/or the data in the file to be merged will need editing first. For instance unwanted data in the file to be merged could be removed.

Close

Closes the current document window. A prompt is displayed if it has been modified, allowing you to save the file first, or to cancel the Close operation.

Compress Files When Saving

If ticked, then all saving of database files will be done in a compressed format, which will make files 10 - 20 times smaller on disk. Make sure this option is unticked if a file needs to be in a text format for reading by third party products e.g. XLG configuration. Versions of SmartConfig earlier than 1.3.0.0 can open only uncompressed files. This setting will be remembered across SmartConfig sessions.

Save

Saves the file for the current document window in SmartConfig format.

Save As

As for save, but allows saving of the file with a new name.

Note that you have the option of saving it as a template. See [Template Files](#)^[18].

Export in Panel Format

This command is only available for some panel types. It exports the current document window to a file in the format required for export to the panel.

See also [Transfer to / from Panel](#)^[9], which gives a more direct method of sending the database directly to the panel.

Select Default Data File Location

This command enables you to set the default location for loading and saving data files. The folder you select is remembered across SmartConfig sessions.

The default folder for "Save As" of a file not created from new will be the folder the file was loaded from.

If no folder has ever been selected with this command then the default folder will be something like C:\Documents and Settings\All Users\Documents\SmartConfig (it varies across Windows versions). Note that with previous versions of SmartConfig, if no default had ever been selected with this command, the default folder was then something like C:\Program Files\Vigilant\SmartConfig. If you have upgraded from a previous version, you should now set the default folder to locate your previous data files, or move the files to the new default folder. These changes in SmartConfig are mandated for Windows Vista compatibility.

When a second or subsequent file is opened, the dialog box will start in the folder where the last file was loaded from (even if this is not the set default data file location). However if the default data file location is changed, then when another file is opened, the dialog box will start in the new location.

Print Table

Prints the currently visible table for the current document window.

Print All

Prints all data for the current document window (usually many pages).

PDF

Prints all data for the current document window into an Adobe Acrobat .PDF file (to read use Adobe Reader or similar). When selected, a dialog box will open to allow the file name and location to be chosen. Use this feature to create a document for later printing, or as a record of the site's database that can be read without SmartConfig.

Compare

Compares two databases and displays (and optionally prints) the differences. To use this command you must open just the two databases you want to compare, and no others. The newer database should be on top (have focus). The compare function has some intelligence (for instance added points do not have their default parameters listed).

Terminal Window

Starts a terminal emulator to connect to the diagnostic terminal of a panel. You need to select the panel type so that the correct baud rate is automatically selected. The terminal can connect directly to the panel over an RS232 connection (using a COM port on your PC), or indirectly over a Telnet (TCP/IP) connection using, for example, the Internet, a corporate WAN, etc. See [Terminal Window](#)¹⁸. The terminal will only "know" what kind of panel is connected if you have a file open, in which case it will assume the connected panel matches the panel type of the currently selected database.

Transfer [Panel Type] DB to/from Panel

For the appropriate Panel Type, sends the current database, or a file for the same panel type, from SmartConfig to the Panel, or retrieves a database from the Panel into SmartConfig (or optionally saves it to disk for some panel types). Refer to more specific instructions for the panel type you are using. Look up "Transfer to/from Panel" in help for more specific help based on the panel type.

NOTE With some panels this command will do the same as "Terminal Window", and you will need to then click "Send Database" or "Capture Database" to start the transfer.

Transfer Selected DB Type to/from Panel

This is the same as the above "Transfer DB to/from Panel", except instead of using the current panel type, it

allows you to select which panel type. For some panel types this will open the "Terminal Window", with the terminal then "knowing" what kind of panel it is connected to.

Recently Used Files

The last 4 files opened or saved by SmartConfig will be listed here. When the mouse cursor is placed over each file, its full file name and location will be shown in the status bar at the bottom of the SmartConfig window. Click on a file name to open it.

Exit

Exits the program.

2.2 Edit

Undo

Undoes the most recent change (e.g. typing in a single cell, multiple cells changed with cut, delete, paste, fill down, or fill series, or a change to a logic equation).

With tables and forms, multiple levels of undo are possible - until you switch to another table. The menu will change to inform you of the next type of operation that will be undone.

Note - consequential changes may not be "undone".

When editing a text page, only one level of undo is provided.

Copy

Copies the selected cells to the Windows clipboard. (Note - select the cells by dragging the mouse, or by clicking in one corner of a rectangular area, and Shift-clicking in the opposite corner.)

The clipboard may be pasted into SmartConfig, or other Windows applications such as Excel. To paste into a table in Word, you must either first create a table in Word, and select exactly the right number of rows and columns before pasting, or just paste as text, then select what you just pasted and "convert text to table". Alternatively paste into Excel first and then copy and paste from Excel to Word.

Copy with Header Row & Fixed Cols

Copies the selected cells along with the fixed (light grey) cells above and to the left of the selected area. (There is no other way of selecting these fixed cells). The selected cells do not need to be adjacent to the header row and fixed columns.

This command copies selected information in a table along with the relevant column headings and row identifiers, in a way suitable for pasting into another application.

Paste

If only one cell is selected, this pastes the clipboard into a rectangular area with the top left corner in the current cell.

If an area is selected, its width in cells must be the same as that of the clipboard. Its height must be at least that of the clipboard. The clipboard is pasted into the selected area as many times as will fit vertically. (One example of this being useful would be to select the same point type for every 4th point, with all the intervening points being unused. Select the required point type for point 1. Select points 1 to 4 and "Copy". Select points 5 to 250 and "Paste". It may then be useful to "View used rows".)

The source of the information can be SmartConfig or a spreadsheet such as Excel. You can use this feature to import point text, zone names, etc., from other sources.

Cut

Copies the selected cell(s) to the clipboard, and then clears the cell(s).

Delete

Clears the selected cells.

Fill Down

Copies the contents of the top cell(s) of the selected area into all other rows of the selected area. You can use this to quickly set a number of adjacent cells to the same value - if necessary using filter or sort first to group the cells you want to change together.

Fill Series

Fills the selected cells with a series with a uniform increment equal to the difference between the top selected cell and the second top selected cell. If this increment is not a number between 1 and 10, 1 is assumed. You could use this for example to map a number of sequential circuits to sequential zones.

If the top selected cell contains alphabetic parts as well as a numeric part, the numeric part will be incremented. For example "Zone 1 text" will result in "Zone 2 text", "Zone 3 text", and so on.

Edit Cell

Allows you to edit a grid cell. If the cell contains a number or text, you can edit it in the edit box at the top without destroying the cell's initial contents. If the cell is multichoice, you can select from the choices in a popup menu. If it is a yes/no choice, it will flip.

Select All

Selects all cells if a table is displayed, or selects all text if a text page is displayed.

Insert Row Above

Inserts a blank row above the row the cursor is on.

Delete Row

Deletes the row the cursor is on.

Add Logic Block

Shows a sub-menu of logic blocks available for the current panel type. The logic blocks are listed by the name of the configured logic blocks and their parameters. Click on the logic block to be created. A dialogue box is displayed, which prompts for the information required. When correctly entered, press OK to create the logic block. If a logic block requires an entry to be made, or the entry is in an incorrect format, the cursor will return to the entry box that needs attention. Cancel will abort the entry.

Edit Logic Block

Shows a sub-menu of current logic blocks that may be edited. Click on the logic block to be edited. All current settings will be displayed, and changes to those settings can be made. Click OK to save these changes.

Delete Logic Block

Shows a sub-menu of current logic blocks that may be deleted. Select the logic block to be deleted and confirm the deletion. Note that if a logic block made changes in tables (e.g. the DSS table) then those changes need to be manually adjusted.

2.3 Select

The select menu provides an alternative method of selecting a table to edit. It has the same function as the listbox on the left of the screen. The advantage of the Select menu is that it does not need a mouse - type Alt+S, then the underlined letter.

The names of the tables vary according to the type of panel currently being edited. Refer to the panel-specific sections for the table details.

2.4 Profile

This gives a selection of "Profiles" to edit. Profiles contain tabular data like ordinary tables, however the data is usually predefined and does not require editing by the user.

Generally profiles provide named groups of predefined settings which can be selected by name in other (normal) tables. For example the required thresholds and filtering settings for a "Type A" heat detector.

You can create your own profiles if you wish, just add extra rows to a profile table. It may be useful to use SmartConfig's copy and paste facility to make a new row which is the same as an existing row, and then changing the data you want to change. Ensure that each row of the table has a unique name.

WARNING Changing the settings in profiles may result in the system not being Standards compliant.

2.5 View

As Table

Refer to [table view](#)^[16].

As Form

Refer to [form view](#)^[17].

Quick Start

Show (and allow editing of) only the most commonly required settings. This setting is available for only some panel types.

Advanced Mode

Show all settings i.e. cancels Quick Start. This setting is available for only some panel types.

The Quick Start / Advanced Mode setting is remembered across SmartConfig sessions.

Show All Rows/Unsort

Makes all rows of the current table visible (e.g., after a "Filter", "Show Used Rows", or "Collapse All"). Also returns the sort order to the default order.

Show Used Rows

Makes only the currently used rows of the active table visible. NOTE - the selection of rows displayed may not necessarily continue to be "used rows" after any data is changed.

Collapse All

On a table that uses + and - icons to show (expand) or hide (collapse) sub-items (e.g., *MX1* Points table), this will collapse all items, causing only rows that are not sub-items to be displayed.

Go to Related Table

Goes to another table showing data relating to the current cell, positioning this data at the top of the view.

Back

Goes back to the previous table.

Sort Ascending

Sorts the table so that the column containing the current cell is in ascending order. (For integer columns the order is numeric. For other columns the order is alphabetical). NOTE - the order of rows displayed may not necessarily continue to be sorted after any data is changed.

This command is also available by right clicking in the desired column.

You can sort according to the contents of more than one column, by sorting on the least significant column(s) first, then finally the most significant column.

To return to the normal order, use the command View | Show All Rows / Unsort.

Sort Descending

As above but in the opposite order.

Filter...

Allows you to display only, or all but, the rows where the column value matches a value which you enter. (By default the value is that of the current cell.)

If the text you enter ends in *, this * can be used to match any characters (or no characters). For example "First Floor*" will match "First Floor North Wing", "First Floor South Wing", and "First Floor" by itself.

This command is also available by right clicking in the desired column.

Successive Filter commands will remove more and more rows. To cancel one filter before applying another, use the command View | Show All Rows / Unsort before applying the second filter.

NOTE - the selection of rows displayed may not necessarily continue to obey the filter after any data is changed.

To cancel filters use the command View | Show All Rows / Unsort.

Move Column Left

Moves the column containing the current cell, one position to the left. Note that currently this setting is lost when you exit the program.

Move Column Right

As above but moves the column right.

Find

Displays a dialog box for you to enter some text to find in the current column of a table displayed in table or form view, or in a text page.

If a table or form is being displayed, the search starts downwards in the current column. (In form view the current field is searched while scanning forwards through the remaining records). If the bottom of that column is reached, you will be given the choice of restarting at the top of the same column, searching any remaining columns, or cancelling. If you choose to search remaining columns, that choice will stay in effect until a new "Find" is started.

For both table view and form view, any rows which are not visible due to a Filter will not be searched.

This command is also available by right clicking in the heading of the desired column.

Find Next

Finds the next occurrence of the text.

2.6 Check

Check O/P Logic

Checks the syntax of the output logic or scripts (if present / available). Errors are explained and the offending line will be highlighted.

Check Tables

Checks all tables for consistency and errors. Also checks output logic or scripts (if present / available). Errors will be explained and the current cell positioned so that you can fix the problem. Warnings and information will be displayed in a results window.

Show CRC

Calculates and displays a "CRC" (check word) of the configuration data.

This CRC is stored in the database sent to some types of panels, and can be displayed on the panel's LCD and/or diagnostic terminal so that you can check if the file you have open in SmartConfig corresponds with what is in the panel.

This feature may be added to other panel types in the future.

This CRC is not the same as those currently displayed in an MX4428 panel.

This new CRC differs from the existing CRCs used for checking Flash / EEPROM chips in the panel, which are different every time you transfer the data to a panel, as such data includes time and date and other varying data. The new CRC is dependent only on the data you enter into SmartConfig.

Note - the CRC is calculated over **all data** you can enter, even data that makes no difference to the operation of the panel (e.g., Notes in tables and comments in logic). If you want the CRC feature to be most useful, make sure that you don't change the database after transferring it to the panel.

The CRC **may** change with new versions of SmartConfig.

2.7 Window

This menu contains the usual Multiple Document Interface commands, including tile / cascade etc, and a list of open files to select from.

Note that if more than one file is open, you can also select which one to edit by clicking the file's [open file tab](#) [16].

2.8 Tools

Program Firmware

This allows you to program the firmware of those panel types that support on-site programming of their firmware.

Additional tools may be available for specific panel types. Refer to the panel-specific sections for details.

2.9 Help

General and panel specific help

This displays the complete help file for SmartConfig including all supported panel types. This includes general help for SmartConfig relevant to all panel types, plus specific help for each panel type supported by the version of SmartConfig.

Context Sensitive Help

Displays help for the table you are editing or screen you are viewing. The same help can be obtained by pressing F1.

SmartConfig Manual

Displays the "general and panel-specific help" (as described above) in Acrobat PDF format, suitable for printing.

Help for Individual Panels

You can display help for the specific panel types supported by your version of SmartConfig. This may be less confusing than the overall help, especially when using the index and search features.

What's New

Shows changes in SmartConfig since its older versions.

Licence

Shows the SmartConfig licence.

About

Shows information about SmartConfig, and the operating system on the PC you are using.

3 General Reference

This is a general reference description about the use of SmartConfig that applies to ALL system types. System-specific additional information is available in the relevant sections.

3.1 General Editing Instructions

Open File Tabs

When more than one file is open, tabs are shown below the toolbar with one tab for each open file. Clicking a file's tab will bring that file to the front.

Keyboard Shortcuts

Many of the menus and keys can be activated with the keyboard.

To activate a top level menu or visible button, press Alt + the underlined key on the menu or button text. Individual menu items may have a shortcut key. This key is shown to the right of the menu text. These shortcut keys include Ctrl+G to go to the table related to current cell, and Ctrl+B to return back to the previous table.

Resizing

You can re-size the SmartConfig window (depending on your video card and monitor) by dragging the edges of the window. SmartConfig will remember your settings for the next time you run it.

Undo

To undo changes to the current cell, or a number of cells altered by a single command (e.g. Paste), press Alt+Backspace or Ctrl+Z. Multiple levels of undo may be performed within a single table - it may be better to use the [edit](#) ^[10] menu so you can see a description of the next undo action.

Undo history is lost when changing to a different table.

Input Validation

Some validation of input is performed during typing -

1. if the cell should contain a number you can only type digits.
2. if the cell should contain a list of numbers you can only type digits, commas, and spaces.
3. if the cell should contain a string in a particular format you may only be able to type the appropriate keys

When entering data into a cell which should contain a single number, the number may be adjusted to fit within maximum and minimum limits. In table view you can see the adjusted value in the grid as you type into the top edit box. In form view the number will be adjusted as you exit the cell.

Some cells which usually contain a number may have special cases that are displayed in words e.g. "Default", "Disabled", "Alt", etc. You can select the special cases by typing the first character of the word.

Further validation of input is done as a table is exited, i.e. as another table is selected. If there is a problem the cell causing the problem will be highlighted in red and you will be given the choice of stopping to fix the problem immediately, or temporarily ignoring the problem so that it can be fixed later or fixed by editing **another** table. This can happen on cut and pasting invalid data into a cell, or on upgrading an older database and the old field type (e.g., profile) does not exist.

Further checking is done as a database is exported in panel format. Finally the [check tables](#) ^[14] command does all the previous checks and also warns you about things which **might** be errors.

Table View

In table view you can see/edit multiple entities of the same type, e.g., multiple zones. However sometimes not

all the information may fit on the screen so it may be useful to select [Form View](#)^[17], which displays one entity at a time.

Use the mouse to select a cell to edit. Or navigate to it with :

1. TAB (moves right)
2. SHIFT+TAB (moves left)
3. Up arrow (moves up)
4. Down arrow or ENTER (moves down)

To overwrite the text in a cell, just start typing. To edit the text, press F2, or click in the wide edit box near the top of the SmartConfig window. When editing the text of a cell, the cursor will always be positioned in the wide edit box.

You can change column widths (not saved when you exit the program) by dragging the divider between columns in the header row.

A number of common "Edit" and "View" commands are available with a **right mouse click**. The commands vary depending on whether the mouse is positioned over the heading (top) row of the table or a data row. You can right click a fixed column (a light grey column with fixed information) - this is the only way to sort or filter based on the fixed columns, or to find a cell of a fixed column containing a specific value.

Form View

In Form View you can see only one entity at a time, e.g., one zone. This is the default view for one-off entities, e.g., the System form and the Network form (system dependant).

Use TAB and SHIFT+TAB, or the mouse, to move to another field. To move to another entity (e.g., another zone), use the Next or Previous button.

Most cells can be edited in the form. However if you want to edit a cell where the text does not fit in the edit box on the form, it can be edited in the wide edit box by clicking there.

Passwords (where applicable) are normally displayed as asterisks, e.g., *****. This prevents casual observers from seeing secure information. However if you want to check a password, select it and then double-click in the wide edit box at the top of the screen.

Status Display on Title Bar

The title bar of the each window displays the filename of the window and the name of the currently visible table. The filename will be preceded by an * if it has been modified but not saved. If the table displayed is sorted or filtered, "Sorted or Filtered" will be appended.

If the document window is maximised (the default) it does not have its own title bar, and the information for the current window will be displayed in the application title bar.

Status Display on the Status Bar

There is a "Status Bar" at the bottom of the SmartConfig window. This often contains "hints" for the menu command under the cursor, including the full pathname of files on the recently used list. Otherwise it contains the full pathname of the active document.

Previous Button

Moves to the previous row of the table or previous entity in form view.

Next Button

Moves to the next row of the table or next entity in form view.

Find Button

The same as the [Find](#)^[13] menu item.

Find Next Button

The same as the [Find Next](#)^[14] menu item.

Notes column in tables

Many tables have a "Notes" column. This is for entering textual notes for your own use, and for the use of subsequent programmers. It has no effect on the operation of the panel.

In some cases, the "notes" may be displayed in SmartConfig as "bubble help" when a multi choice selection can be made from the rows of the table.

3.2 Template Files

One or more template files for each panel type will be supplied with SmartConfig.

Template files are a starting point for new databases, and contain many settings and profiles. [File | New](#)^[7] gives a choice of template files to start a new job with. Sometimes multiple templates for a panel type will be provided with SmartConfig (e.g. different templates for Australia and New Zealand), and furthermore you can create your own templates.

WARNING. Many of the settings in template files are required for Standards compliant operation. This applies particularly to "Profiles" (for those panel types that have profiles). Do not change the settings unless you are sure that they will not affect Standards compliance.

Creating new Templates

Starting from an existing template (i.e. [File | New | Panel Type | TemplateName](#)), edit it as required. Click [File | Save As](#). Fill in the Change Log. In the Save As dialog box, click the "Save as type" drop down box, and select template files. Type in a name with no extension. Click Save. Templates stored in the "data files" folder (see [Default Folder](#)^[8]) are now available under "File" | "New". It is no longer necessary to save them in the SmartConfig program folder.

This new template will then be available when you click "File | New".

It is recommended that you do **not** overwrite the templates supplied with SmartConfig (and stored in the program folder), as your customised version will be overwritten when you install a new version of SmartConfig.

Deleting Templates

You can delete template files in the normal manner in Windows Explorer, My Computer, or even a File Open or File Save dialog box. They will then disappear from the File | New menu.

3.3 Terminal Window

The terminal window provides a terminal emulator for use as the diagnostic terminal of a panel. It can connect to several products from Johnson Controls Christchurch, and the settings (baud rate, databits, stop bits, parity etc) are pre-programmed for these products.

It can display the 24 lines of the current "terminal" plus 1000 previous lines (the scrollbar area). The 24 current lines are highlighted (compared with the scrollbar lines). The scrollbar can be used to see the scrollbar area.

It interprets cursor addressing and colour commands sufficiently to function as a terminal for an MX4428 in PanelX mode, and to display colour when used as an MXP diagnostic terminal.

It can use a serial port on the PC, or connect to a panel over a TCP/IP (Telnet) connection. In the latter case, the panel will usually be connected to an "RS232 to Ethernet adapter" that provides Telnet (TCP/IP)

connectivity to a local area network (for example a PIB).

The Telnet feature allows remote fault diagnosis over the Internet, provided your PC is connected to the Internet and the panel is connected as described below. It also potentially allows remote configuration. Note that transferring of configuration databases remotely will require someone on site to change the Write-Enable jumper as required, and to fully test the system after completion of the download.

The baud rate (for direct RS232 connections) is selected by choosing the panel type on the File | Terminal Window Menu, or once within the terminal by clicking the Menu button or right-clicking the screen.

Once the terminal window has been opened, you can reactivate it by clicking in it, or if it has become lost behind the main SmartConfig window click Window | Terminal, or click the terminal icon on the toolbar.

The following commands and settings are at the top of the terminal window.

Comms Port

The port (An installed COM port, a USB RS232 serial adapter, or Telnet) can be selected.

NOTE The port will be remembered and automatically used the next time you start the terminal window.

When you select **Telnet**, you must enter the host name or IP address, and optionally the port number, of the Ethernet adapter connected to the panel. **Note** Telnet has been successfully tested over a fast network to a PIB and to a Lantronix "RS232 to Ethernet" adapter, in each case connecting to an MX4428, MX1, and QE90. The use of Telnet over a wireless or other possibly slow connection has had only limited testing at this time and is not guaranteed. Future information about SmartConfig's Telnet capabilities will be made available as it becomes available.

The RS232 to Ethernet adapter requires programming as follows -

| | MX4428 / QE90 | MX1 |
|----------------------------|-------------------------|-------------------------|
| Baud | 9600 | 19200 |
| Databits | 8 | 8 |
| Parity | None | None |
| Serial Flow Control | X-On / X-Off | None |
| Network Protocol | Raw TCP/IP (not Telnet) | Raw TCP/IP (not Telnet) |

It will also require an IP address and one or more port numbers set up. You will need to get this information from the administrator of the Local Area Network it is connecting to, and possibly get the administrator to arrange access to this IP address and port from the Internet.

Auto Navigate

When ticked, SmartConfig will automatically navigate to the right point when sending a database to the panel, or capturing a database from the panel, and automatically navigate to the "normal running" state when complete. When not ticked, you must navigate manually.

XOff

Use XOn / XOff flow control in both directions. Normally this should be ticked.

However if you are sending or capturing a binary file, it should be un-ticked. (Please note that in normal operation with supported panels, this parameter will adjust itself as needed.)

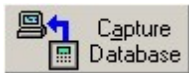

Capture Database

Capture a database from the connected panel and open it, or save it to a file. This is done with in-built knowledge of the type of panel and the required protocol. (Note - the "end" of the captured database is automatically recognised.)

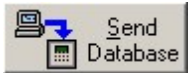

Send Database

Send the current database, or a file, to a panel. This is done with in-built knowledge of the type of panel and the required protocol. The "current database" is the database represented by the topmost window of SmartConfig, and its name will be shown as a hint when you pass the mouse cursor over the button.

Close

Close the Serial port or TCP/IP connection, and the terminal window.

Return

Return to SmartConfig's main window, leaving the Terminal window running. Alternatively click on the main window.

Menu

Brings up a menu of commands to print and/or copy areas of the display. The same menu can also be obtained by right-clicking the terminal window. Commands include

- **Clear** - erase all lines including the scrollbar region.
- **Copy Selection** - copy the selected area* of the screen to the clipboard.
- **Copy Screen** - copy the 24 current (highlighted) lines to the clipboard.
- **Copy Screen + Scrollback** - copy all lines to the clipboard (including the scrollbar area starting with the first non-blank line).
- **Copy Visible Area** - copy all the lines currently visible in the window to the clipboard.
- **Print Screen** - print the 24 current (highlighted) lines.
- **Print Visible Area** - print all the lines currently visible in the window.
- **Send File** - Send an arbitrary file which you can select to the remote device. The file is sent with no knowledge of the remote device or protocol. When sending, the menu item will change to "Cancel Sending File", and clicking it will cancel the send function. When cancelled, or the file is completely sent, the button will change back to "Send File" again.
- **Capture to File** - Capture data received from the remote device to an arbitrary file which you can select. The data is captured with no knowledge of the remote device or protocol. When capturing, the menu item will change to "Cancel", and clicking it will cancel the capture and close the file.
- **Baud Rate** - Select a different baud rate.
- **Options** - Select various options for the terminal. See below.
- **Display Rxd characters in Hexadecimal** - Display characters received from the host as hexadecimal codes rather than as characters. For example a received A is displayed as 41. Note that this option toggles on / off each time it is selected, with a tick is displayed for it when it is active.

* To select an area of the screen or scrollbar area (for the copy selection command) click and hold the mouse left button in the top left of the required area. Drag the mouse to the bottom right of the required area then release the left button. Hold down the Alt key while dragging to select a rectangular area rather than all text between the first character and last character. To select more than is initially visible, move the mouse below the bottom row of the terminal screen image, and the window will scroll up. When a selected area is active, typing Control-C will copy the selected area. Otherwise, Control-C and any other control characters typed will be sent to the host.

Terminal Options

The codes sent by function keys and arrow keys can be programmed by clicking **Options** on the terminal

menu. Select the string of characters to be sent by each function key F1 - F12 by typing the characters into the F1 - F12 edit boxes. To insert or append an <Enter> key, click the **Insert Enter Key** button. A ¶ character is displayed to represent the <Enter> key. To insert an arbitrary 8 bit character, click the **Insert Hex code Prefix** button. A § character will be displayed. Follow this by the hexadecimal code for the character required, i.e., two characters, each in the range 0-9 or A-F. For example, §1B represents an ESC character.

The effect of the arrow keys can be programmed to emulate an ANSI/VT100 terminal, or an ADDS ViewPoint terminal.

Note that the selections for functions keys and arrow keys will be effective immediately and can be used by clicking on the terminal window without closing the Options window. If the **Cancel** button on the Options window is later pressed, the key settings will return to what they were. This ploy can be used to temporarily set new strings to the function keys without changing those saved.

The **Select Background Colour** and **Select Foreground Colour** buttons allow any colours to be set as the default text background / foreground colours for the terminal. Note that these may be over-ridden by colour controls from the host. When you click on a colour in the displayed spectrum, you can then select lighter and darker versions of it on the resulting right-hand colour gradation. Then click "Add to Custom Colours", and click the box for the custom colour you have just added. The background colour selected is used by SmartConfig when bright white or no text background colour is selected by the host, and the foreground colour selected is used by SmartConfig when black or no text foreground ground colour is selected by the host.

Note : If the F1 key is programmed to send a character string, then it will not bring up (this) help for the terminal. Press Shift+F1 for help.

3.4 Password Strength

A warning will be produced for configured passwords that don't meet the following criteria:

- 1) Be at least 8 characters long and contain characters from at least three of the categories below:
 - a) Uppercase letter (A - Z)
 - b) Lowercase letter (a - z)
 - c) Numeric digits (0 - 9)
 - d) Special or punctuation characters (!"#\$\$%&'()*+,-./:;<=>?@[\\]^_`{|}~)
- 2) Alternatively the password may simply be at least 20 characters long.

4 FP1600 / Omega 64 System

This contains information about using SmartConfig to program an FP1600 / Omega 64 system's database.

4.1 FP1600 Overview

Overview

FP1600 / Omega 64 is a conventional Fire Alarm System that can be expanded in multiples of 16 zones from 16 zones (1 FP1600 board) to 96 zones (1 Master FP1600 board and 5 Slave FP1600 boards).

Each board provides the following programmable inputs and outputs.

1. Input circuits programmable for different modes of operation
2. Ancillary Relay Output (default function "Common Fire")
3. A20 - On board open collector output (default function "Common Defect")
4. A21 - On board open collector output (default function "Common Normal")
5. A1-A19 - 19 programmable open collector outputs (default function matches earlier model LED mimic connector).

Related Documents

Refer to document LT0196 "FP1600/OMEGA 64 FIRE ALARM SYSTEM TECHNICAL MANUAL" for more information on the FP1600 and document LT0312 "FP1600/OMEGA 64 FIRE ALARM SYSTEM INSTALLATION AND CONFIGURATION MANUAL" for details on installation and configuration.

Hardware / Software Requirements

To use SmartConfig, the FP1600 board(s) must be Mk 3 or later hardware which is clearly identifiable as it has a 9 way D serial connector and a 3 digit display. These boards will have version 4.00 software or later.

Terminology

| | |
|---------------------------|--|
| Circuit | An input (1-16) of a board. |
| Zone | A system-wide numbering scheme for circuits, whereby circuits on the first board are zones 1-16, circuits on the second board are 17-32, etc. Referred to as Z_n where n is 1 to 96. |
| Group | A set of circuits on the same board which must ALL be in alarm to activate the group. Referred to as G_n where n is 1 to 8. |
| Universal Variable | (Also simply Variable). There are 16 universal variables which are common across the system. These can be activated by zones and groups, and can themselves activate ancillaries. Referred to as U_n where n is 1 to 16. |
| Ancillary | The ancillary relay output (referred to as AR) , or one of 21 ancillary open collector outputs of a board which may drive relays (referred to as A_n where n is 1 to 21). |
| System | The collection of FP1600 boards intercommunicating to act as one. |

In SmartConfig, when qualification is required to identify which board a group or an ancillary is on (for instance in the Mapped To and Mapped From columns of the Variables Notes table), it will be preceded by B_n where n is the board number (1-6). For instance B1G2 means group 2 of board 1.

Programming Concepts

For each FP1600 board, its 16 zones may be mapped individually to groups on the same board (to provide an N of N or logical AND function), to (system wide) universal variables (to provide a 1 of N or logical OR function), and directly to that board's ancillary outputs (which generally operate using a logical OR of the conditions

mapped to them).

Depending on each zone's programming, the zone status will map to system conditions such as common fire, common defect, bell ringing, brigade calling, etc.

Groups may be mapped to universal variables and directly to ancillary outputs on the same board.

Universal variables can be mapped to ancillary outputs on each board..

Additionally some system states can be programmed to activate (or deactivate) ancillary outputs.

The universal variables are common across the (up to 6) FP1600 boards in a system and they provide the only way of transferring data across boards (apart from common system states which are automatically calculated).

The following diagram shows these relationships :

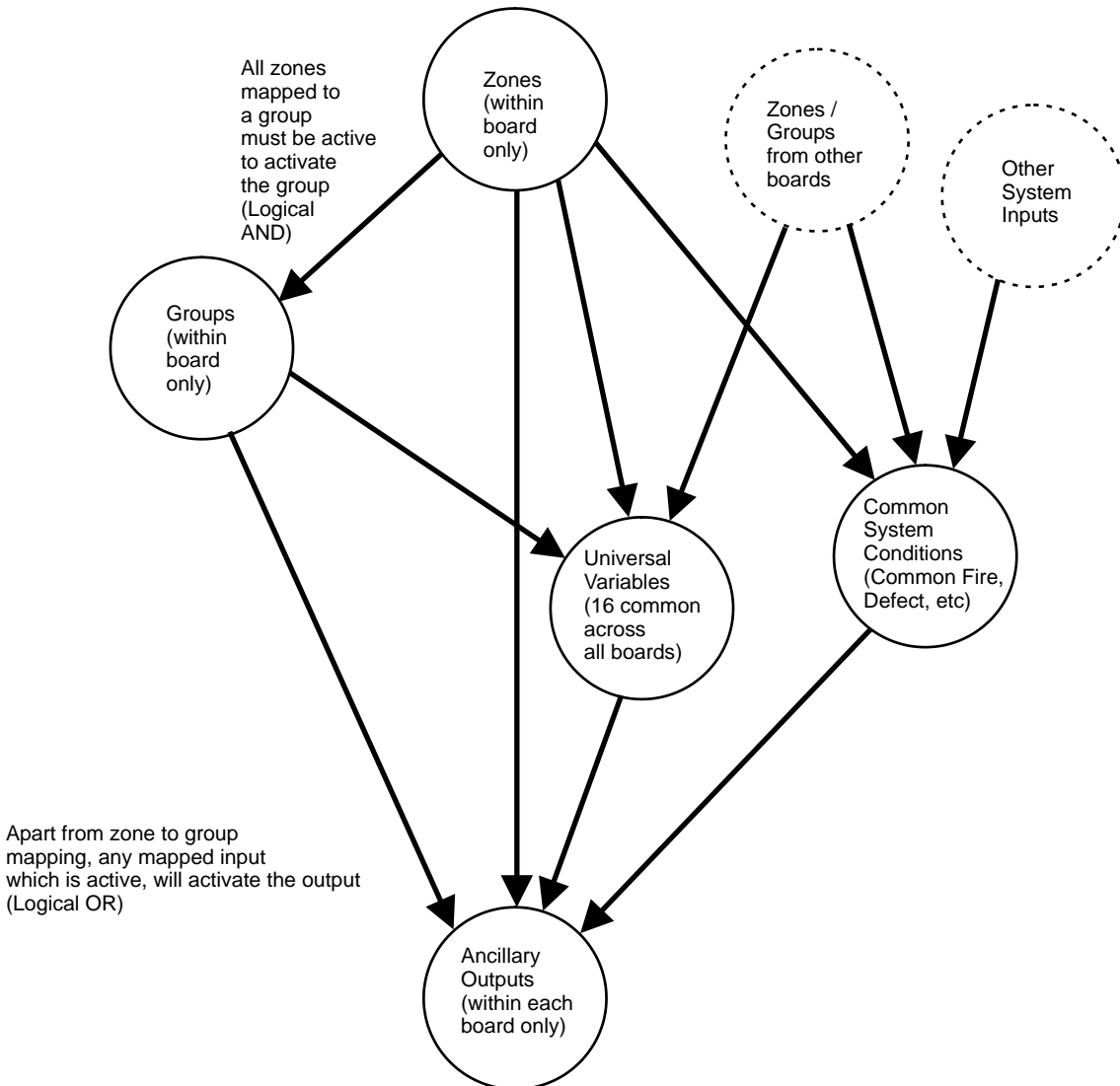

4.2 FP1600 Version Differences

Overview

Two distinct versions of FP1600 are supported by SmartConfig:

1. Version 4 software.
2. Version 5 software and later.

Version 5 software was introduced for compliance with NZS4512:2003, which required the definition of new circuit types.

When a panel is configured, the [System Config](#)^[31] page must be set with the correct software version for each board. (Mixed versions are permitted in a multiboard system.)

The circuits supported by version 4 software will now be referred to as legacy circuits within SmartConfig and may only be programmed for a version 5 board if legacy circuits are enabled for that board on the [System Config](#)^[31] page.

Circuits

The four default circuit types for version 5 are:

- Detector (dEt)
- Residential (rES)
- Flowswitch (FL)
- Evacuation Control (Ec) (Board 1 only)

The letters in the brackets indicate the display on the FP1600 board 7 segment display display.

All of these new circuit types register Defect on open or short circuit, as per the new requirements of the standard.

The legacy circuits are displayed on the FP1600 board 7 segment displays as follows -

| Legacy Circuit Type | Display on Version 4 board | Display on Version 5 board |
|---------------------|----------------------------|----------------------------|
| Smoke | S | LS |
| Thermal | th | Lth |
| Combined | Co | LCo |
| Residential | rE | LrE |
| Flowswitch | FL | LFL |
| Evacuation Control | Ec | LEc |

4.3 FP1600 Getting Started

Start with [File | New](#). Select the type of panel you want to configure.

If the number of boards is higher than 1, enter the number of boards on the [System Config](#)^[31] page.

Check and adjust the settings on the [Zones](#)^[25] and [System Config](#)^[31] pages as required.

If you have special output requirements, program the relationships between zones, groups, universal variables, and ancillaries, as per the previous section ([FP1600 Overview](#)^[22]). But note that the default programming is adequate in many cases.

Download the database to the system as described in [Communicating with the FP1600 Panel](#)^[32].

4.4 FP1600 Tables

This describes each of the "tables" used for FP1600 Configuration.

4.4.1 Zones

Allows the programmable settings for each zone to be configured.

Board No.

The board number in the system (1-6) - fixed. Board 1 is the Master.

Circuit No.

The circuit number for the zone input wiring on the board (1-16) - fixed.

Zone No.

The logical zone number (1 - 96) (16 x (Board No. - 1) + Circuit No.) - fixed.

Zone Name (optional)

Enter a name for the zone here. Shown on subsequent pages for configuring zones.

Circuit Type

The types of circuits which may be selected depend on whether the board is Version 4, or Version 5, and if it is Version 5, whether Legacy mode is enabled. Refer to [FP1600 Version Differences](#)^[23].

For version 4 you can select from Disabled, Smoke (legacy), Thermal (legacy), Residential (legacy), Combined (legacy) or Flowswitch (legacy). Board 1 also has Evacuation Control (legacy) as a selection.

For version 5 you can select from Disabled, Detector, Residential, or Flowswitch. Board 1 also has Evacuation Control as an options. If "Legacy mode" on the System Config page is enabled, all the version 4 (legacy) circuit types are also available.

Default characteristics for each circuit type are loaded whenever a change is made.

Callpoint

Select this option if there is/are Call Point(s) with contact conversion modules on the circuit. (Smoke (legacy) or Residential (legacy) circuit types only).

Gated

Select if AVF gating is to be used for smoke detectors. (Detector, Residential, Smoke (legacy), Residential (legacy) or Combined (legacy) circuit types only).

Latching

Select for latching of the alarm state (until a Panel Reset occurs).

Brigade Calling

Select alarm types for which the brigade is called - none, MCP (option for Residential circuits only) or All.

Bell Ringing

Select alarm types for which the bells ring (i.e. evacuation output activates) - none, MCP (option for Residential circuits only) or All.

Power

Flowswitch, Evacuation Control, Thermal (legacy), Flowswitch (legacy) and Evacuation Control (legacy) circuits can be set for Low or High Power. (High power provides better immunity from interference but draws more quiescent current).

Residential Smoke Alarm on zone LED

Residential circuits can be set to display smoke alarms on their zone LED by selecting the 'indicated' option.

Notes

Use this space to include additional information about each zone.

4.4.2 Zone Map Ancil

Allows mapping of the zones of each board to the ancillary outputs 1 - 21, or the ancillary relay of that board.

Board No.

The board number in the system (1-6) - fixed. Board 1 is the Master.

Circuit No.

The circuit number for the zone input wiring on the board (1-16) - fixed.

Zone No.

The logical zone number (16 x (Board No. - 1) + Circuit No.) - fixed.

Zone Name

The zone name as entered on the Zones page.

Ancil Relay, A20, A21, A1 - A19

Set the alarm conditions for each zone for which each ancillary output/relay on the same board will be activated

| Selection | Meaning | Notes |
|-----------|----------------|---|
| No | No conditions | |
| All | All conditions | |
| MCP | MCP only | Only available for Residential circuits |
| Smk | Smoke only | Only available for Residential circuits |

Notes

Use this space to include additional information about each mapping.

4.4.3 Zone Map Groups

Allows mapping of the zones of each board to the groups 1 - 8 of that board.

Board No.

The board number in the system (1-6) - fixed. Board 1 is the Master.

Circuit No.

The circuit number for the zone input wiring on the board (1-16) - fixed.

Zone No.

The logical zone number (16 x (Board No. - 1) + Circuit No.) - fixed.

Zone Name

The zone name as entered on the Zones page.

Grp 1 - 8

Set the alarm conditions on each zone for which each group on the same board will be activated -

| Selection | Meaning | Notes |
|-----------|----------------|---|
| No | No conditions | |
| All | All conditions | |
| MCP | MCP only | Only available for Residential circuits |
| Smk | Smoke only | Only available for Residential circuits |

Remember that a group will become active only when **all** zones mapped to it are active.

Notes

Use this space to include additional information about each mapping.

4.4.4 Zone Map Variables

Allows mapping of the zones to the universal variables 1 - 16. The universal variables are shared across all boards.

Board No.

The board number in the system (1-6) - fixed. Board 1 is the Master.

Circuit No.

The circuit number for the zone input wiring on the board (1-16) - fixed.

Zone No.

The logical zone number (16 x (Board No. - 1) + Circuit No.) - fixed.

Zone Name

The zone name as entered on the Zones page.

U1 - U16

Set the alarm conditions on each zone for which each variable will be activated

| Selection | Meaning | Notes |
|-----------|----------------|---|
| No | No conditions | |
| All | All conditions | |
| MCP | MCP only | Only available for Residential circuits |
| Smk | Smoke only | Only available for Residential circuits |

Note that the variables are universal and so do not belong to any particular board. Any activated zone or group condition on any board will activate a variable it is mapped to.

Notes

Use this space to include further information about the mapping.

4.4.5 Group Config

Allows the settings for each group to be programmed.

Board No.

The board number in the system (1-6) - fixed. Board 1 is the Master.

Group No.

The group number on the board (1 - 8) - fixed.

Mapped From

Lists zones that map to this group.

Mapped To

Lists ancillaries and/or variables that the group maps to.

Group Name (optional)

Enter a name for the group here. Shown on subsequent pages for configuring groups.

Latching

Select for the group's state to be latched (until a Panel Reset occurs).

Brigade Calling

Select for the group to call the brigade.

Bell Ringing

Select for the group to ring the bells (activate the evacuation output).

Notes

Use this space to include further information about the group.

4.4.6 Group Map Ancil

Allows the mapping of groups to ancillary outputs 1 to 21 or the ancillary relay to be set. (Mapping is only possible within a board).

Board No.

The board number in the system (1-6) - fixed. Board 1 is the Master.

Group No.

The group on the board (1 - 8) - fixed.

Mapped From

Lists zones that map to the group.

Mapped To

Lists variables that the group is mapped to, as entered on the Group Map Variables page.

Group Name

Name of the group as entered on the Group Config page.

Anc Relay, A20, A21, A1 - A19

Ancillary outputs or relay on the same board to be activated when the group is activated.

Notes

Use this space to include additional information about each mapping.

4.4.7 Group Map Variables

Allows the mapping of groups to the system-wide universal variables 1 to 16.

Board No.

The board number in the system (1-6) - fixed. Board 1 is the Master.

Group No.

The group on the board (1 - 8) - fixed.

Mapped From

Lists zones that map to this group.

Mapped To

Lists ancillaries that this group is mapped to, as entered in the Group Map Ancil page.

Group Name

Name of the group as entered on Group Config page.

U1 - U16

Universal variables to be mapped to by the group. Note that the variables are universal and so do not belong to any particular board. Any activated group or zone on any board will activate a variable it is mapped to.

Notes

Use this space to include additional information about each mapping.

4.4.8 Ancil Config

Allows the settings for each ancillary output on each board to be programmed.

Board No.

The board number in the system (1-6) - fixed. Board 1 is the Master.

Ancil No.

The designation of the ancillary on the board - fixed.

Mapped From

Lists zones, groups and variables that map to the ancillary output.

Latching

Select for the output state to be latching (until a Panel Reset occurs).

Follow Trial Evac

Select if ancillary is to be forced on by the External Evacuation Switch.

Follow Silence Alarms

Select if ancillary is to be forced off by the Silence Alarms Switch.

Obey Services Restore

Select if ancillary is to be forced off by the Services Restore Switch.

Follow Lamp Test

Select if ancillary is to be forced on by Lamp Test.

Follow Evac Relay

Select if ancillary is activated by the Evacuation (bells) relay.

Follow Common Fire

Select if ancillary is activated by Common Fire.

Follow Common Defect

Select if ancillary is activated by Common Defect.

Follow Common Normal

Select if ancillary is activated by Common Normal.

Follow Charger Inhibit

Select if ancillary is activated by Charger Inhibit.

Follow Panel Reset

Select if ancillary is activated by Panel Reset.

Notes

Use this space to include additional information about each ancillary.

4.4.9 Ancil Map Variables

Allows the mapping of universal variables to ancillary outputs.

Note that the layout of this table is different to other tables - in this case the columns are the inputs and the rows are the outputs.

Board No.

The board number in the system (1-6) - fixed. Board 1 is the Master.

Ancil No.

The number of the ancillary on the board (A1 - A21, Anc Relay) - fixed.

Mapped From

Lists the zones and groups that map to each ancillary.

U1 - U16

Select to map the universal variable to each ancillary.

Notes

Use this space to include additional information about each mapping.

4.4.10 Variables Notes

Page for entering additional information about the universal variables.

Variable No.

The universal variable U1 to U16. Fixed.

Mapped From

A list of zones and groups (on various boards) that map to the variable.

Mapped To

A list of ancillaries (on various boards) that the variable maps to.

Notes

Use this space to include additional information about each variable.

4.4.11 System Config

Allows the system configuration settings to be set.

Number of boards in system

A system is made up from one master and up to 5 slaves. This specifies the total number of boards.

Brigade

Specifies whether the system is connected to the brigade, or if it operates in Local Mode.

Master Door Open = Services Restore Active

Select this option if the master cabinet door open is to have the same effect as operating the Services Restore Switch.

Global Flowswitch Delay

Specifies the global flowswitch delay in seconds (0 to 25 in multiples of 5).

Battery Low volt adjust

Specifies adjustment to the Battery Low Defect voltage threshold. Allows an offset from the default value (P0) up to 500 mV above (P5) or down to 700 mV below (-7).

Number of RZDUs in system

Specifies the number of RZDUs that are connected to the system (0 up to 8). Note - include only **replying** RZDUs, non-replying RZDUs (such as an IO-NET controller) should not be included in this number.

Evacuation Supervision

Select separately for each board as to whether it supervises its evacuation (bells) output.

Firmware Versions

Select the version of software that is running in each board being configured.

Enable Legacy Devices

Select for any version 5 boards that are to be configured with legacy circuits.

Residential Circuit Delays

Specifies the delay in seconds for each board (0 or multiples of 10 up to 250). A value of zero selects latching operation with no automatic reset of the residential smoke detectors. Otherwise this is the delay before a residential smoke detector alarm condition is automatically reset.

4.4.12 Change Log

Information is requested each time the configuration .f16 file is saved. This is stored on the Change Log page. It records the date, name of the person who made the changes, and a description of the change made.

4.4.13 Comments

Any information not already defined or described on earlier pages can be stored here for future reference.

4.5 Download / Upload

This describes the procedure for downloading a database to the FP1600 panel, and uploading a database from the FP1600 panel.

4.5.1 Communicating with the FP1600 Panel

A window is brought up by the Download to / Upload from Panel command on the File menu to control communications between SmartConfig and the FP1600 Panel.

Overview

To program or read the information in a multi-board (Omega 64) system, each board must be programmed or read individually. A Serial cable (LM0076) must be connected between the PC and each board in turn, and each board programmed or read from in turn.

It is often necessary to power a board down and up in order to get into "Programming Mode". You will be prompted when this is needed. When in Programming Mode, the display on the board will indicate 'ACO'.

When reading or writing the data in a board, you must select the board number, or select "Auto". If you select "Auto", SmartConfig will read the existing board number from the connected board and write or read the data for that board. If you select a board number other than Auto, SmartConfig will check that the existing number of the connected board matches the selected board number. If it does not match you can continue if you choose, and if you are writing the database, the board number of the connected board will be changed to the selected board number.

Note - A Master database cannot be written into a Slave board and a Slave database cannot be written into a Master board.

However the data from a Slave board can be read into the Master portion of SmartConfig's database, and data from a Master board can be read into the Slave portion of SmartConfig's database. SmartConfig will ask you to confirm this operation twice. You must check (and amend as required) the resulting data carefully. (At least the system data may be wrong.)

Reading Configuration From a Panel to SmartConfig

1. Select Write / Read Panel Database from the File menu.
2. Select the board to be read from and the serial port to use.
3. Connect a LM0076 serial cable to the serial port on your PC and the programming port of the desired FP1600 board.
4. Click the Read Database button.
5. If prompted, turn the panel power off and on. (If the board is already displaying 'ACO', this will not be necessary).
6. SmartConfig will initiate communications with the board and read the EEPROM contents.

If there are more boards to read from, repeat from step 2 for each board. Otherwise, click "Close" to exit.

NOTE - when extracting databases from an FP1600/OMEGA64 panel using Smart Config, it is necessary to extract the database from the master board first, before the slave boards, so that the correct number of boards is assigned before reading any slave databases.

Writing Configuration From SmartConfig To a Panel

1. Select Write / Read Panel Database from the File menu.
2. Select the board to be written to and the serial port to use.
3. Connect a LM0076 serial cable between the serial port on your PC and the programming port of the desired FP1600 board.
4. Insert the "Data Program Enable" link on the FP1600 board.
5. Click the Write Database button.
6. If prompted, turn the panel power off and on. (If the board is already displaying 'ACO', this will not be necessary).
7. SmartConfig will initiate communications with the board and write into the EEPROM contents.
8. Remove the "Data Program Enable" link.

If there are more boards to write to, repeat from step 2 for each board. Otherwise, click "Close" to exit.

Note

Always save the file on your PC (and back it up) as well as writing it to the panel. All the "Notes" and "Comments" are only saved on the PC file. They are not saved in the panel.

4.6 FP1600 Reference

This contains general reference about using SmartConfig to configure an FP1600.

4.6.1 Checks

Checking a database ([Check | Check Tables](#)^[14]) checks the following and violations are reported as warnings

1. Any zones that have been mapped to a group that isn't mapped anywhere.
2. Any zones that have been mapped to a variable that isn't mapped anywhere.
3. Any groups that have been mapped to a variable that isn't mapped anywhere.
4. Any groups that have been mapped to variables or ancillaries, but have no zones mapped to them.
5. Any variables that have been mapped to ancillaries, but have no zones or groups mapped to them.

5 IO-NET

This describes SmartConfig's IO-NET compiler and facilities for programming an IO-Net Controller, and for extracting programs from an IO-Net Controller.

For further information refer to LT0115 VIGILANT IO-NET PROGRAMMABLE CONTROLLER USER'S MANUAL.

See the following pages (press next at the top of the page, or expand the table of contents), for more details.

5.1 Opening Files

SmartConfig can open both the old style of IO-NET files prepared by a text editor (usually *.txt) and the new files saved by SmartConfig (*.ion).

Old Style Files (*.txt)

To open an old style file, click File then Open. With the "Files Of Type" drop-down control, choose the "Import text files (*.txt)" option. (Alternatively if the extension of your file is not .txt, choose the "All Files (*.*)" option.) Browse to the file you want to import and click "Open".

Most of the file will be imported into the Logic page, however the parameters will be separated out and displayed in the Parameters page. A matching network profile will be chosen, or a new one added if the network parameters do not match a standard configuration. Note that as the standard network profiles for 2400 baud, 4800 baud, and 9600 baud are all the same, 2400 baud may be chosen even if the actual baud rate in the system is 4800 baud or 9600 baud. It is suggested that you change the Network Profile on the Parameters page to match the actual baud rate of the system so that the system will be documented correctly.

At the start of the logic, there may be a large number of Comment lines, i.e. lines starting with ;. These lines would have previously documented the parameters which have now been stripped out. They can now be deleted.

SmartConfig Files (*.ion)

These files will load exactly as they were saved.

5.2 Parameters

This section describes the Parameters page.

The following parameters can be set on the Parameters page.

| | |
|--------------------------|---|
| System Name | Enter a name for the system, for documentation purposes only |
| Network | Enter the required network profile. The choices available will be the entries in the Network Profiles ^[55] table. Normally you only need to select a choice with the required baud rate and modem selection. |
| Specify Address | Refer to Address ^[36] . |
| Address | Refer to Address ^[36] . |
| Max Stations | Refer to Max Stations ^[36] . |
| Connects to RZDU | Refer to RZDU Number ^[36] . |
| RZDU Number | Refer to RZDU Number ^[36] . |
| RZDU Protocol | Refer to RZDU Protocol ^[37] . |
| TX Zone Data | Refer to TX Zone Data ^[37] . |
| Allow Reduced RAM | Refer to Allow reduced RAM ^[38] . |
| Total User RAM | Refer to Off-line RAM Assumptions ^[39] . |
| Base Page RAM | Refer to Off-line RAM Assumptions ^[39] . |

See the following pages (press next at the top of the page, or expand the table of contents), for more details.

5.2.1 Address

The address of the target IO-NET controller into which the source file is to be programmed can be specified with the controller number 0 to 127 as the Address in the Parameters page. This must be the same number as assigned to the address dipswitch on the IO-NET Controller.

Normally it is not necessary to specify the address of the target station in the user source file. Instead select the radio button "Use DIP Switch".

The parameter to assign the address should be included only if a "Ram limit exceeded" error is produced by the compiler. In this case select "Specify here also to reduce RAM required" and specify the Controller address in the "Address" box. It is important that the EPROM be installed in a target controller with **the same address set on the DIP switches**. If not, the controller may display an error cadence on its status LED after power up and not run (see LT0115 Section 7).

This parameter is referred to as ADDR in LT0115.

5.2.2 Max Stations

Max Stations should be assigned a value of 0 to 255 to match the number of the highest controller address you are ever likely to connect to the network. Any controller connected to the network with an address higher than this will not be given access to the network. A reasonable upper limit value should be used for Max Stations. Too large a value can reduce the efficiency of the network and increase the start-up time of the network or increase the access time when adding a new station to the network. Too low a number means you may need to reprogram some controllers when adding to the network later.

The information in the following paragraph may be useful if adding new stations to an existing network and the new stations have addresses greater than the value of the max station parameter on the existing controllers.

It is not essential for all stations to have the same value for max stations, but is probably desirable. For a given station N, it gets access to the network only if the next lowest numbered controller present on the network has a max stations greater than or equal to the value N. For example, if controllers 5,7 and 12 are the only controllers physically present on the network then the max stations value of controller 7 determines whether controller 12 gets access to the network - BUT, note that if controller 7 disconnected from the network for a while it would then be the max stations value of controller 5 which determined controller 12 access.

Note that in non programmed mode a default value of 31 is assigned for max station.

This parameter is referred to as MXST in LT0115.

5.2.3 RZDU Number

Zone status used in the control program may come from either a local RZDU data connection or from zone data received on the IO-NET network from other controllers which have their own RZDU data connection.

Each controller which has a local RZDU data connection must have the "**Connects to RZDU**" box ticked and a panel number (0-63) associated with that particular fire panel in the box "**RZDU Number**".

Each controller with a local RZDU connection should be given a unique panel number, so that the particular panel's data can be identified on the network. These should be carefully recorded in the documentation of the

system.

Refer to [F3200 / MX4428 / MX1 Zone Data](#)^[44] for details of how to access data from RZDU connections in your logic.

Notes

SmartConfig is not able to detect duplication of panel numbers. However an IO-NET controller is able to detect such duplication and will set the ZNF operand to TRUE if it receives a message of zone data from the network where the panel number is the same as its own RZDU connection panel number.

The local RZDU data connection may be enabled even if none of the zone data from it is accessed in the control program - this could happen if it was desired for the controller to transmit the zone data onto the network. A controller may access zone data from either or both its own RZDU data connection (if any) or zone data received from the network.

Refer to LT0115 Section 3.4.6 and and Section 8 for information on RZDU zone data refresh rates and the delay from a zone change of state occurring to the new state being received by an IO-NET controller.

This parameter is referred to as RZDU in LT0115.

5.2.4 TX Zone Data

A controller may be programmed to transmit all of the zone data it receives on its local RZDU data connection onto the IO-NET network for use by other controllers. To enable the transmission of local RZDU data onto the network, Tick the box "**TX Zone Data**". The parameter, RZDU Number, described above, must also be included. The panel number specified by the RZDU Number parameter will be included in every message of zone data transmitted onto the IO-NET network so that other controllers can identify the zone data.

NOTE - for a network using 1200 baud modems the transmission of zone data takes up a significant amount of time on the network and if a controller does not get an opportunity to transmit often enough, it may have to continually discard some of the zone status data that it receives from its RZDU input - which could result in the status of some zones NEVER being transmitted on the network. Refer to LT0115 section 8.4 for further information.

This parameter is referred to as TXZD in LT0115.

5.2.5 RZDU Protocol

The data received on the local RZDU connection from an MX4428 / F3200 / MX1 fire panel can be in one of two different formats or "protocol types". Older versions of F4000 panels transmit data in a format referred to as "LED protocol" and newer versions of MX4428/F3200 panels can be programmed to transmit using this or the newer "LCD protocol". MX1 panels can only transmit data using the newer "LCD protocol". The older LED protocol transmits only led/zone status and the newer LCD protocol also sends event text and information for display on a remote LCD and allows more functions for isolating/ resetting zones from remote RZDUs/RDUs. Refer to LT0115 Section 8.2 for information on how to configure an MX4428 fire panel.

Select one of the Radio buttons to select the correct protocol for the RZDU.

If an IO-NET controller is connected to an MX4428 / F3200 / MX1 fire panel which is transmitting the wrong version of the RZDU protocol, then the IO-NET controller will not operate correctly.

This parameter is referred to as RZDP in LT0115.

5.2.6 Allow reduced RAM

If the compiler produces a "RAM storage limit exceeded" error the "**Allow Reduced RAM**" tickbox may need to be ticked to reduce the size of the RZDU buffer (if any) allocated in the controller. The size of the buffer is set by the compiler and affects the capability of the controller to transmit zone data onto the IO-NET network. The "Allow Reduced RAM" parameter has no effect (and is greyed out) if the controller is not programmed to transmit zone data onto the network.

If the controller is programmed to transmit zone data onto the IO-NET network then the compiler will attempt to allocate an RZDU receive buffer size of at least 60 bytes - this is twice the size of the maximum sized message which can be received on its local RZDU data connection. The controller receives a message of zone data on its RZDU data connection once every 2 seconds, but is not able to transmit this data onto the network immediately - it must store it briefly until it gets an opportunity to transmit it onto the network.

The average and maximum lengths of time the controller must wait before it can transmit this zone data onto the network is dependent on the baud rate of the network, the number of controllers connected to the network, also the "activity level" of the network. Some approximate figures are given in Section 8.4 for the length of time a controller may have to wait before it is able to transmit on the network.

When the controller gets an opportunity to transmit on the network it will immediately transmit all of the zone data that it currently has stored in its buffer (which could require multiple messages being transmitted - and it may also transmit the status of its own input points) before relinquishing transmission right to the next controller.

The controller must therefore have a large enough RZDU receive buffer to be able to store a reasonable amount of zone data while it is waiting for the opportunity to transmit it. On a typical system a controller would get an opportunity to transmit more often than once every 2 seconds so that the message of zone data which it receives from the RZDU data connection every 2 seconds has probably been completely transmitted by the time the next RZDU message is received.

However, there may be times when the controller has not transmitted the last data received from the RZDU input. The size of the buffer set by the compiler determines how much zone data the controller can store while it is waiting to transmit it.

Since the controller has only a relatively small amount of total RAM storage space (approximately 130 bytes available to the user for a standard HC705C8 eprom type) some flexibility has been provided by the compiler to allow some control of the size of the RZDU buffer allocated.

If the controller has its local RZDU data connection enabled but is not programmed to transmit zone data onto the IO-NET network then the compiler will allocate an RZDU receive buffer size of minimum 30 bytes - this is all that is needed to store the maximum size message that can be received from the RZDU input and the controller never needs to store more than one message at a time. (In actual fact the compiler will allocate all of the free RAM it has available to the RZDU buffer which may result in a buffer size of more than 30 bytes).

If the controller is programmed to transmit zone data onto the network then the compiler will initially attempt to allocate a minimum of 60 bytes to the buffer - which it will probably be able to do for a lot of control programs, however some larger programs may not have enough free RAM for a 60 byte buffer. By including the MRAM parameter the controller will allow the buffer size to be reduced to a minimum of 30 bytes. To enable this feature, tick the box "Allow reduced RAM".

The compiler will ALWAYS allocate all of the free RAM it can to the RZDU receive buffer so that the buffer size could be set at any value from 30 to 60 bytes when the Minimise RAM parameter is enabled.

This parameter is referred to as MRAM in LT0115.

5.2.7 Off-line RAM Assumptions

When compiling **offline** (see [Checking a Program](#)^[56]), SmartConfig by default assumes the chip will be a C8/C8A and the controller software version 2.01. (In this case there are 141 bytes of total RAM and 61 bytes of base page RAM available in the target.)

If you know the chip will be a C9A and the software Version 2.01, you can set "Total User RAM" to 189 and "Base Page RAM" to 77.

Other software versions may have different amounts of RAM available. You can check that your program will fit by compiling **online** (see the Compile Only command in [Programming an IO-NET Controller](#)^[57]).

5.3 Output Logic

This section describes the text you can type in the Logic page.

See the next few pages (press next at the top of the page, or expand the table of contents), for more details.

5.3.1 General Format

The Logic page may contain any number of output logic expressions (limited only by the available space in the target EPROM) which assign the value of an expression to a local output or internal variable or timer.

e.g. $O4 = I7/9O \text{ OR } I15/1A \text{ AND } V3$; to control output 4

and may also assign values to logic variables

e.g. $V5 = V4 + I3/26A$

and to timers

e.g. $T1[15,25] = I1/4S$

At run time the target controller will evaluate all of the logic expressions sequentially in exactly the order they appear in the logic page .

When the controller gets to the end of the logic expressions it returns to the start and cycles through forever.

Expressions which assign values to outputs do NOT have to appear in numerical order of the output number. They may be in any order - however, the order that the expressions appear in the source file does NOT determine the order in which the PHYSICAL output changes. The physical state of the outputs is only updated at the completion of each pass through the entire list of logic expressions (and also at intervals of 100 milliseconds) so that the actual state of the physical output may not necessarily follow the logical state of the output generated by the logic expressions if the logical state changes quickly.

There does not have to be a logic expression for every output.

The same output should be controlled by ONLY ONE EXPRESSION and the compiler will display a warning message if more than one expression is given for the same output.

e.g. $O5 = V1 \text{ OR } V2$
 $O6 = I1/1A$
 $O5 = O6 \text{ OR } I29/3S$

is controlling output 5 with two different expressions and the actual state which appears at the physical output

will be intermittent.

Similarly, the program should not contain more than one expression defining the input condition and start/stretch delays of the same timer.

The compiler will display a warning if this is done. The state of a timer may be accessed as many times as desired in multiple equations on the "right hand side" of a logic expression.

Expressions which assign values to variables may be in any order with more than one expression for the same variable being allowed if desired. The variable will then keep that value until the next occurrence of an expression which assigns a value to that variable. It is recommended that the same variable is not used for two different purposes except perhaps by an experienced user or if the compiler produces a "RAM limit exceeded" error.

Comments may be included anywhere in the source file. Any text on the same line following a semicolon ; is treated as a comment with the exception of the semicolon used in the NA function.

Be careful not to unintentionally convert a real logic expression into a comment by accidentally placing a semicolon at the start of or part way through, a logic expression.

Blank lines may appear anywhere in the source file.

Each logic expression must fit entirely on a single line but long lines are allowed- up to 299 characters. Variables can be used to simplify complex or long expressions. Following the last logic expression in the file, the keyword END must appear on a new line to terminate the list of expressions. Any lines following the END statement may contain comments only.

Upper or lower case characters are allowed everywhere and are treated identically.

A logic expression does not have to start in column one, it may start in any column ie. a logic expression may be preceded by any number of blanks on that line.

In general, individual operands such as I15/3A should not contain any embedded blank characters (in some cases this is not strictly enforced and embedded blanks are allowed) but spaces may be used freely between operands and operators.

It is not essential to have any spaces between operands and operators but they should be included for clarity.

Each logic expression is of the form :

Ox = Operand {Binary operator Operand} ...

to assign the state of output x (x = 1 to 32)

or

Vx = Operand {Binary operator Operand} ...

to assign a value to logic variable x (x = 1 to 256).

or

Tx[mmm,nnn] = Operand {Binary operator Operand} ...

to define the input condition and timer delays (start, stretch) for timer x (x = 1 to 128). The start delay (mmm) and stretch delay (nnn) are required and may be any value from 0 to 255 seconds.

The curly brackets {} which are not part of the expression indicate that their contents are optional and may be repeated any number of times. The right hand side of each expression consists of one or more operands with each pair of operands separated by a binary operator.

All operands return a logical value of TRUE or FALSE. If the right hand side of an expression evaluates to TRUE then the specified output on the left hand side will be turned ON (and FALSE = OFF) or if the left hand side is a variable, then the variable will be assigned a value of TRUE or FALSE. See [Timers](#)^[49] for more details on the operation of timers.

If the output or variable which appears on the left hand side of the = also appears as an operand on the right hand side then the value used on the right hand side is the value of the operand before the new assignment.

Any operand may be preceded by the unary operator NOT (the symbol ^ may also be used) which complements the value of the operand.

Each operand may itself consist of an expression enclosed in parentheses () with a maximum nesting level limited by the amount of stack space required for evaluation at run time. The nesting level limit is 16 which is more than enough for any foreseeable requirement.

See also [Example Programs](#)^[55].

5.3.2 Operators

The binary operators which may be used are:

- AND - logical AND (alternatively use .)
- OR - logical OR (alternatively use +)
- XOR - exclusive OR

The one unary operator which may be used is:

- NOT - logical complement (alternatively use ^)

The single character "+" (plus) may be used instead of OR, the character "." (fullstop) may be used instead of AND, and the character "^" may be used instead of NOT.

The truth tables for AND,OR,XOR and NOT are (F = FALSE, T = TRUE)

| | | | |
|---------|----------|----------|---------------|
| A AND B | <u>A</u> | <u>B</u> | <u>RESULT</u> |
| | F | F | F |
| | F | T | F |
| | T | F | F |
| | T | T | T |

| | | | |
|--------|----------|----------|---------------|
| A OR B | <u>A</u> | <u>B</u> | <u>RESULT</u> |
| | F | F | F |
| | F | T | T |
| | T | F | T |
| | T | T | T |

| | | | |
|---------|----------|----------|---------------|
| A XOR B | <u>A</u> | <u>B</u> | <u>RESULT</u> |
| | F | F | F |
| | F | T | T |
| | T | F | T |
| | T | T | F |

| | | |
|-------|----------|---------------|
| NOT A | <u>A</u> | <u>RESULT</u> |
| | F | T |
| | T | F |

Example NOT A OR NOT B

| | | | |
|--|----------|----------|---------------|
| | <u>A</u> | <u>B</u> | <u>RESULT</u> |
| | F | F | T |
| | F | T | T |
| | T | F | T |
| | T | T | F |

5.3.3 Order of evaluation

The order of evaluation of operands is important and can affect the result of the expression.

When more than one operand appears in an expression, the order of evaluation of the operands is not necessarily left to right but depends on some rules as follows:

- A. The contents of parentheses are evaluated first.

e.g. O3 = V1 AND (V2 OR V3)

will cause "V2 OR V3" to be evaluated first with the result being "ANDed" with V1 resulting in the following truth table.

| | | | |
|-----------|-----------|-----------|-----------|
| <u>V1</u> | <u>V2</u> | <u>V3</u> | <u>O3</u> |
| F | F | F | F |
| F | F | T | F |
| F | T | F | F |
| F | T | T | F |
| T | F | F | F |

| | | | |
|---|---|---|---|
| T | F | T | T |
| T | T | F | T |
| T | T | T | T |

B. Each of the operators AND, OR, XOR and NOT have a priority which determines the order of evaluation when not overridden with parentheses as follows:

The NOT operator has highest priority, AND has the next highest priority, and OR and XOR have equal and lowest priority. Where operators have equal priority the order of evaluation is left to right.

E.g., NOT V1 AND V2 has a truth table of:

| <u>V1</u> | <u>V2</u> | <u>RESULT</u> |
|-----------|-----------|---------------|
| F | F | F |
| F | T | T |
| T | F | F |
| T | T | F |

with the "NOT V1" being done first

but NOT (V1 AND V2) has a truth table of:

| <u>V1</u> | <u>V2</u> | <u>RESULT</u> |
|-----------|-----------|---------------|
| F | F | T |
| F | T | T |
| T | F | T |
| T | T | F |

E.g. V1 OR V2 AND V3 results in the "V2 AND V3" being evaluated first because the AND operator has a higher priority than OR.

Operators of equal priority result in evaluation of operands from left to right. E.g. V1 OR V2 XOR V3 OR V4 XOR V5 will result in the operands being evaluated in the order they appear with V1 first and V5 last.

If unsure, use parentheses. The use of parentheses does not affect the size of object code generated.

5.3.4 Operand Types

This describes the 7 different Operand Types

1. The condition of one of the 32 inputs on the local controller or inputs on a remote IO-NET Controller received via the network.
2. The state of a local output on the controller.
3. The condition of any zone on a MX4428 / F3200 / MX1 system received via either an RZDU connection directly wired into the controller or from zone data received on the IO-NET network.
4. The state of a local variable V1 to V256.
5. The "State" of an NA function.
6. System conditions and constants including the "scan status" of any IO-Net controller or MX4428 /

F3200 / MX1 fire panel RZDU data link.

7. The state of a timer.

5.3.4.1 IO-NET Inputs

The four conditions of a circuit input may be accessed as follows:

lx/yO (open circuit)
 lx/yN (normal)
 lx/yA (alarm)
 lx/yS (short circuit)

Where x is the address of an IO-NET Controller 0 to 255, y is the number of a circuit input 1 to 32 and O, N, A, S refer to the four voltage bands where S is the lowest band (short circuit) and O is the highest (open circuit). The operand returns true if the circuit input x/y is in the specified condition O, N, A or S at the time the logic expression is evaluated.

NOTE - currently the maximum address which can be physically set (with dipo switches) on a controller is 127 but the compiler allows a controller number of 0-255 to be used in expressions.

The circuit input x/y can be any input on any IO-NET controller including the inputs of the controller running this program.

E.g. O1 = I3/15A OR I0/32S results in output 1 being on if either input 15 on controller 3 is in Alarm or if input 32 on controller 0 is in short circuit.

When the controller is first powered up the initial state of all inputs will be normal until their true state is received either from the network for remote controller inputs or from input boards for local controller inputs. If a local input termination board is not connected the associated inputs will all be in an open circuit condition.

5.3.4.2 IO-NET Outputs

The local outputs can appear as an operand on the right hand side of an expression as:

OxF or OxN where x is the number of an output 1-32

NOTE It is not possible to use output states of other controllers.

OxF returns TRUE if the output is OFF, otherwise FALSE.

OxN returns TRUE if the output is ON, otherwise FALSE.

E.g. O2 = O1F OR O32N; will result in output 2 being ON if output 1 is off or output 32 is on.

After power-up or re-start of the controller all outputs will initially be off.

5.3.4.3 F3200 / MX4428 / MX1 Zone Data

The condition of a zone on an MX4428 / F3200 / MX1 fire panel may be accessed as follows:

| | |
|----------|---|
| Zpp:nnnA | returns TRUE if zone in alarm and NOT isolated |
| Zpp:nnnF | returns TRUE if zone in fault and NOT isolated |
| Zpp:nnnI | returns TRUE if the zone is isolated |
| Zpp:nnnN | returns TRUE if the zone is normal (not isolated, not in fault, and not in alarm) |

where pp is a panel number, 0-63, nnn is a zone number 1-528. Zone data from multiple fire panels may be accessed but the total number of panels accessed should be 8 or less.

Each IO-NET controller which has an RZDU data link directly connected is programmed with a panel number and whether the zone data should be transmitted over IO-NET or not. The zone data which it transmits onto the IO-NET network will include the panel number for identification by other controllers. Any controller may access zone data from both its own directly connected RZDU data link and from zone data which it receives via the IO-NET network.

e.g. O32 = Z3:1A AND Z4:528N
 results in output 32 being on if zone 1 on panel 3 is in alarm (and not isolated) and zone 528 on panel 4 is normal.

When the zone corresponds to an Ancillary Control Zone on MX4428 / MX1 or a relay on an F3200 FIP then the conditions A,I,F,N are

| | |
|----------|--|
| Zpp:nnnA | returns TRUE if zone activated and NOT isolated |
| Zpp:nnnF | returns TRUE if zone in fault and NOT isolated |
| Zpp:nnnI | returns TRUE if the zone is isolated |
| Zpp:nnnN | returns TRUE if the zone is normal (not isolated, not in fault, and not activated) |

After power-up or restart of the controller the state of all zones will initially be normal until the current actual state is received. This could take up to 7 or 8 minutes for a system with 528 zones depending on which version of software is being used in the MX4428 / MX1 panel. In the latest version of MX4428 panel software the time to refresh the state of all 528 zones is approximately 70 seconds.

5.3.4.4 Variables

Variables may be used for storage of logical values.

A variable is accessed with Vnnn where nnn is a value 1-256.

There are up to 256 variables available, the actual number will be limited by available RAM storage in the controller. A variable has a logical value of either TRUE or FALSE.

E.g. V1 = Z1A OR Z2F
 V2 = I0/1A OR I0/2S
 V3 = V1 OR V2
 V4 = V1 AND V2

Variables should be used "contiguously" starting with V1, then V2, V3 etc, to minimise RAM usage in the IO-NET Controller.

The compiler will display an error message if the RAM storage limits of the controller are exceeded.

When the controller is first powered up or restarted, the initial value of all variables is FALSE.

A variable may be useful for holding the result of an expression which is common to several different logic expressions. This can result in a saving of EPROM space.

Variables are also useful in NA functions because an NA function is not allowed to use an expression in its operand list. This can be overcome by assigning the expression to a variable first and accessing the variable in the NA function.

Variables are also useful for other things. For example, the expression V1 = NOT V1 will toggle the value of V1 each time it is executed and produce an oscillating value.

The expression

V1 = V1 OR ZNF

will latch the occurrence of a zone network fault. (A mechanism to clear this will probably be required.)

5.3.4.5 New Alarm Function

The NA function may be used as an operand in any logic expression and has the form:

NA (reset input; operand list)

where operand list consists of a list of fundamental operands separated by commas and includes:

| | |
|----------|---|
| OnnF | local output nn (1-32) off |
| OnnN | local output nn (1-32) on |
| Ix/yO | input y (1-32) on controller x (0-127) open circuit |
| Ix/yN | input y on controller x normal |
| Ix/yA | input y on controller x alarm |
| Ix/yS | input y on controller x short circuit |
| Vnnn | variable nnn (1-256) |
| Zpp:nnnA | zone pp:nnn (1-528) alarm (and not isolated) |
| Zpp:nnnF | zone pp:nnn fault (and not isolated) |
| Zpp:nnnI | zone pp:nnn isolated |
| Zpp:nnnN | zone pp:nnn normal (not A,I or F) |
| Tnnn | timer nnn (1-128) state |
| IRnnn | IO-NET controller responding status |
| PRnn | Fire Panel responding status |

and "reset input" may be any one of the above fundamental operands, i.e., it is a single operand such as I5/I2S or V15 or Z1:42A, etc.

The operand list may not include expressions i.e. operators NOT, AND, OR, XOR may not be used in an NA function. If it is desired to use an expression in an NA function then the expression should first be assigned to a variable and the variable included in the operand list.

The NA function returns a value of TRUE or FALSE as follows. Whenever any operand in the list has a change of state from FALSE to TRUE then the function returns a value TRUE and continues to return a value TRUE (forever regardless of any further changes of state in the operand list) until the specified reset input has a change of state from FALSE to TRUE. At this point NA returns FALSE and continues to return FALSE until the next change of state from FALSE to TRUE of any operand in the list.

The same operand may appear any number of times in the list.

e.g. NA(I5/I2S; 03N, I7/25A, Z0:124A, V15)

This function is set to TRUE whenever one of the operands in the list becomes TRUE. E.g. if local output 3 changes state from off to on or if input 25 on controller 7 changes state into alarm, etc, and is set to FALSE when input 12 on controller 5 has a change of state into a short circuit condition.

After power up or restart of the controller the initial state (value returned) by all NA functions is FALSE.

The NA function may be used as often as desired (within the limits of RAM storage) in any logic expression.

e.g. O5 = NA(Z12:42F; I2/1A, I2/2A) OR NA(I1/2S; Z1:52A) OR I3/7A

Each NA function uses some RAM storage in the controller, which sets a limit on the number of new alarm functions which can be used. (A function with 6 or less operands in the operand list uses one byte of RAM storage, 7-14 operands uses 2 bytes of RAM).

If there is a large number of operands in the operand list then multiple NA functions can be used to achieve the same thing.

e.g. V1 = NA(I1/1S ; Z1:1A, Z1:2A)
O32 = NA(I1/1S ; V1, Z1:3A, Z1:4A)

is the equivalent of

O32 = NA(I1/1S ; Z1:1A, Z1:2A, Z1:3A, Z1:4A)

Multiple reset operands can be achieved by using two NA functions as shown in the following example.

V1 = NOT V1
V2 = NA(V1; I1/1S, I1/2S, I1/3S)
O32 = NA(V2; I2/1S, I2/2S, I2/3S)

When any of I1/1S, I1/2S, I1/3S have a transition from FALSE to TRUE, the first NA function becomes TRUE so V2 goes from FALSE to TRUE which will provide a reset to the second NA function. The first NA function is being continually reset on every second pass of the equation (since the value of V1 is continually alternating), however, if any of the operands I1/1S, I1/2S, I1/3S become TRUE the NA function will always become TRUE because the operands in the "set list" override the reset operand.

5.3.4.6 System Conditions

INF IO-NET network fault

This returns TRUE if this controller is not regularly receiving input status information from any controller that is required by the output equations or from any controller accessed with the IR operand. If no input status information is required from any other controller and no IR operands are used, then INF will be TRUE if no valid messages of any kind are being received from the network, otherwise INF will be FALSE. INF is prevented from returning TRUE during the first 60 seconds after power-up.

Each controller transmits its input status information on to the network at regular intervals, but will not necessarily include the information in every message it transmits. The rate at which it transmits input information is set by a network parameter and must be often enough to prevent an INF fault occurring at other controllers requiring that data. The rate at which a controller requires to receive input information is also set by a network parameter (DRQT).

ZNF MX4428 / F3200 / MX1 zone data receive fault.

This returns TRUE if the controller is not receiving valid data from the all of the MX4428 / F3200 / MX1 fire panels that it requires. Valid data must be received at least every 32 seconds from each of the panels being accessed with zone operands Zpp:nnnC (where C is A,I,F or N) or being accessed with PRpp (panel responding) - or ZNF will be set TRUE. After being set true the value of ZNF will be updated every 32 seconds and will be set FALSE if it is found that valid data has been received from all required panels. This includes panels for which zone data is received via the IO-NET network and also any direct connection RZDU data link.

ZNF is prevented from returning TRUE during the first 60 seconds after power-up.

ZNF will also be set TRUE if a message is received from the IO-NET network which contains zone data and has a panel number the same as the panel number that has been assigned to the Controller's own RZDU data connection. ZNF will be cleared to FALSE at the next 32 second update time.

ZNF is always FALSE (except for the situation of duplicated panel numbers just mentioned) if the logic expressions do not access any zone status and no PRpp operands are used - even if the local RZDU data link is enabled (by including the RZDU parameter). i.e. if the local RZDU data link is enabled but no zone status or PR operands are used then ZNF will still always return FALSE even if the local RZDU data link fails.

If it is necessary to detect this fault then include a PRpp operand (see below) in the program. ZNF is a non-latching value, however, the occurrence of a fault can be latched with an expression $V1 = V1 \text{ OR } ZNF$, for example, or by an NA function.

IB1 Input termination board 1 status. This returns TRUE if the board is present.

IB2 Input termination board 2 status. This returns TRUE if the board is present.

OB1 Output termination board 1 status. This returns TRUE if the board is present.

OB2 Output termination board 2 status. This returns TRUE if the board is present.

IRnnn IO-NET controller responding status. This may be used to detect a loss of communications with controller nnn. It is necessary to use a timer in conjunction with the IRnnn operand since IRnnn actually returns a value which OSCILLATES between TRUE and FALSE when controller nnn is responding normally. The value of IRnnn operand is set TRUE whenever a message containing input status data (i.e. the status of the 32 input points on controller nnn) is received from controller nnn, but at periodic intervals of several seconds IRnnn is set FALSE and remains FALSE until the next point status data is received from controller nnn.

IRnnn is forced to return TRUE for the first 60 seconds after the controller powers up to allow time for communication with the network to be established.

The rate at which controller nnn transmits its point status data is set by a programmable parameter (DRFT) in the control program running in controller nnn when it is in programmed mode and for a controller running in slave mode the rate is one of 2 fixed values (6 seconds for non modem mode and 12 seconds for modem mode - refer LT0115 section 6.1). Also, whenever a change of state on an input point occurs then that controller will immediately transmit its point status data. The IRnnn operand is set FALSE at periodic intervals according to the value of the programmed parameter DRQT and remains FALSE until the next point status data is received from controller nnn. Hence it is necessary to use a timer to detect the condition of IRnnn returning FALSE continuously for longer than a certain length of time - a time of 30 seconds or more is recommended.

As an example, the following logic will result in output 32 turning on if a period of 30 seconds occurred during which no point status data was received from Controller 16. Output 32 will turn off immediately any point status data is received from Controller 16.

T1[30,0] = NOT IR16
O32 = T1

As a further example, the following logic results in output 32 turning on if, for 30 seconds, no status data is received from Controller 16. The output will stay on, even if point status data is subsequently received, until reset by input I1/1S.

T1[30,0] = ^R16

$$O32 = T1 + (O32N.\wedge 1/1S)$$

When input I1/1 is put into short circuit, output 32 will turn off if the fault has cleared, i.e. if T1 is false. Output 32 will always be on if the fault is still present (T1 TRUE).

The value of DRQT also determines how often the value of the INF operand is updated and is normally set to about twice as long as the value of DRFT. It is not recommended to reduce the value of DRQT to anything less than the default value supplied in the supplied network profiles.

PRnnn Fire panel responding status. This is similar to the IRnnn operand described above and may be used to detect a loss of communications with panel nnn. It is necessary to use a timer in conjunction with the PRnnn operand since PRnnn returns a value which OSCILLATES between TRUE and FALSE when panel nnn is responding normally. The value of PRnnn is set TRUE whenever a valid communication is received from panel nnn (either from the local RZDU input or from zone data received on the network) but at periodic intervals (fixed at 32 seconds) the value of PRnnn is set FALSE and remains FALSE until the next valid communication is received from panel nnn. Normally one communication (a message) is received from each fire panel every 2 seconds, either from the local RZDU input or from zone data received on the network.

PRnnn is forced to return TRUE for the first 60 seconds after power up of the controller to allow time for communication with the network to be established.

As an example, the following logic will result in Output 32 turning on if no message is received from Panel 5 for approximately 60 seconds. The output will turn off as soon as a message is received.

$$T1[60,0] = NOT PR5$$

$$O32 = T1$$

The following modification shows how the output can be latched on until reset by input I1/1S.

$$T1[60,0] = \wedge PR5$$

$$O32 = T1 + (O32N.\wedge 1/1S)$$

5.3.4.7 Constants

TRUE may be used to return the value TRUE.
 FALSE may be used to return the value FALSE.

e.g. V1 = FALSE sets variable V1 to FALSE
 O3 = TRUE turns output 3 on.

5.3.4.8 Timers

A timer can be used to detect a particular condition being continuously TRUE or FALSE for a set length of time. Up to 128 timers may be used but may be limited to less than this depending on the RAM storage limits in the controller. An input condition, start delay and stretch delay must be specified for a timer with a statement as follows.

Tnnn[xxx,yyy] = input condition
 OR Tnnn(xxx,yyy) = input condition

where nnn is the timer number 1 to 128,
 xxx is the start delay, 0-255 (seconds)
 yyy is the stretch delay, 0-255 (seconds)
 and input condition is any valid expression and may include any number of operands, NA

functions etc.

Either [] or () may be used.

The current "state" of a timer is either TRUE or FALSE and may be accessed in an expression with the operand Tnnn, where nnn is the timer number 1-128.

Timer numbers used in a control program should be used "contiguously", starting with 1, to minimise the usage of RAM in the controller. E.g.. if a program needs two timers, then use timers 1 and 2 - don't use timers 5 and 25 as this will waste RAM memory.

The state of a timer is set to TRUE or FALSE as follows.

If the current state of timer nnn is FALSE, then when the input condition has a transition from FALSE to TRUE, the start delay (xxx) starts. If the input condition remains continuously TRUE for the entire length of time specified by the start delay, then the current state of the timer will be set to TRUE – i.e. Tnnn will return a value of TRUE. The current state of the timer will then remain TRUE until the input condition becomes FALSE (and remains FALSE) for the length of time specified by the stretch delay. I.e. if the current state of timer is TRUE, then when the input condition has a transition from TRUE to FALSE, the stretch delay (yyy) starts and if the input condition remains continuously FALSE for the length of time specified by the stretch delay then the current state of the timer will be set to FALSE - i.e. Tnnn will return a value of FALSE.

When the timer is false, if the input condition does not remain continuously true for the full length of the start delay, then the timer will not become true. Similarly when the timer is true, if the input condition does not remain continuously false for the full length of the stretch delay then the timer will not become false.

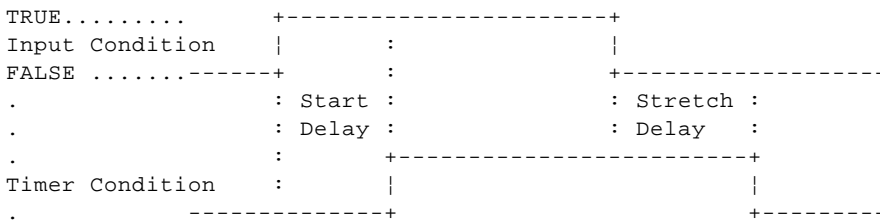

Timer Operation

As the input condition is evaluated only once every pass through the entire control program, short lived changes in the input condition may not cause a timer to start or reset. The time to execute one pass of the control program is dependent on the size of the program i.e. the number and size of the expressions it contains. Typically this could be 100 to 300 milliseconds, but could be as long as 500 to 600 milliseconds for large programs.

If the start delay is zero, then when the input condition becomes TRUE the state of the timer will immediately be set TRUE. Note that the state of the timer only changes when the input condition is evaluated, which is once on each pass through the entire control program. I.e. even with a start delay of zero, short lived changes of the input condition may not cause the timer state to become TRUE. The timer state will become TRUE only if the input condition is TRUE at the time the input condition is evaluated.

Similarly, if the stretch delay is zero, then when the input condition becomes FALSE, the state of the timer will immediately be set FALSE, but note again that short lived changes of the input condition may not cause the timer to change state.

At power up, the state of all timers is FALSE.

The state of a timer, Tnnn, may be used anywhere in an expression and the same timer or any number of timers may be accessed any number of times in the same expression. A timer Tnnn, may also be used in the set list of an NA function and may also be used as the reset operand in an NA function.

Timer example 1

The following example shows how a timer can be used to give an oscillating output with fixed pulse widths of 30 seconds on and 20 seconds off. Output 32 will be on for 30 seconds and off for 20 seconds.

$$T4[20,30] = \text{NOT } T4$$

$$O32 = T4$$

The input condition to timer 4 is NOT T4, hence if T4 is initially FALSE then the input condition will be TRUE, so after 20 seconds the state of the timer will then be set TRUE. This causes the input condition to become FALSE, so the stretch delay (30) starts and after 30 seconds the state of the timer will be set FALSE. The cycle then repeats.

Timer Example 2

This example shows the logic required to achieve the equivalent of the "pulse" timer provided on an F3200 fire panel.

A timer can be used to give a single pulse and then turn off even if the "input condition" remains TRUE. Any input condition can be used - the example uses I1/1S but it may be any expression. When I1/1S has been TRUE continuously for 10 seconds, output 32 will turn on and stay on for exactly 20 seconds, after which it will turn off and stay off even if I1/1S is still TRUE. A transition of I1/1S from FALSE to TRUE is then required to start the process off again. Transitions of I1/1S while the timer is TRUE and output 32 is on are ignored.

$$V1 = I1/1S$$

$$V2 = \text{NOT } T1$$

$$T1[10,20] = \text{NA}(V2;V1) \text{ AND NOT } T1 \text{ AND } V1$$

$$O32 = T1$$

This is a fairly complex example. Suppose the state of the timer is initially FALSE and I1/1S is also FALSE. When I1/1S goes TRUE the NA function will be set TRUE and will remain TRUE until V2 has a transition from FALSE to TRUE (which will occur when timer T1 has a transition from TRUE to FALSE). When the NA function goes TRUE the start delay of the timer will start because the entire input condition is TRUE (V1 is TRUE and "NOT T1" is also TRUE).

After V1 has been TRUE for 10 seconds the state of the timer will become TRUE and output 32 will turn on. Now the input condition to the timer has become FALSE (because "NOT T1" is now FALSE) so the stretch delay starts and after 20 seconds the state of the timer will become FALSE and output 32 will turn off. The transition of the timer from TRUE to FALSE will reset the NA function so that a new transition of V1 from FALSE to TRUE is then required to start the whole process off again.

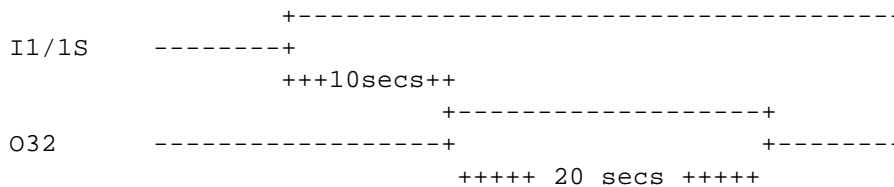

The delay before output 32 turns on is set by the start delay and the length of time that output 32 stays on for is set by the stretch delay.

Timer Example 3 - a Pulse Counter

"Pulse counter logic" may be used to create even longer time delays than the maximum of 255 seconds. The following example uses T5 (Timer 5) as the input condition to count pulses from, but the equation V131=T5

may specify any input condition for which pulses are to be counted, E.g.. a circuit input. (If pulses from a circuit input are being counted, short duration pulses may be missed.)

The following pulse counter logic relies on the fact that the equations are executed EXACTLY in the order shown - which is what an IO-NET controller does.

Note also that ideally a program should allocate variable numbers starting from 1 up contiguously. However, using variable numbers as shown makes the logic easier to understand.

```
T5[13,2] = NOT T5
V131 = T5
V132 = (V132 XOR (^V131.V151))
V151 = V131
V133 = (V133 XOR (^V132.V152))
V152 = V132
V134 = (V134 XOR (^V133.V153))
V153 = V133
V135 = (V135 XOR (^V134.V154))
V154 = V134
V136 = (V136 XOR (^V135.V155))
V155 = V135
```

The state of variable V132 will change every 15 seconds (13+2) at the time that timer 5 has a transition from TRUE to FALSE. I.e. V132 oscillates and is TRUE for 15 seconds and FALSE for 15 seconds.

Variable V133 will change every 30 seconds at the time that variable V132 has a transition from TRUE to FALSE.

Similarly, V134 will change state every 60 seconds, V135 every 2 minutes, and so on, with each successive timer doubling the time period.

Timer Example 4. Long Output Pulses

The pulse counters of Example 3 can be used to generate long time delays. Suppose it is necessary to turn output 32 on for 15 minutes and off for 30 minutes continually. This can be done using the pulse counter equations above but with start and stretch delays in the base timer of 178 and 2. I.e. T5[178,2] = NOT T5.

This means that variable 132 changes state every 3 minutes, V133 changes every 6 minutes, etc.

The following table shows the state of the 4 variables V132-V135 after 3,6,9,12,15..... minutes.

| Time (Minutes) | V132 | V133 | V134 | V135 | Binary Value of Counter |
|----------------|------|------|------|------|-------------------------|
| 0 | F | F | F | F | 0 |
| 3 | T | F | F | F | 1 |
| 6 | F | T | F | F | 2 |
| 9 | T | T | F | F | 3 |
| 12 | F | F | T | F | 4 |
| 15 | T | F | T | F | 5 |
| 18 | F | T | T | F | 6 |
| 21 | T | T | T | F | 7 |
| 24 | F | F | F | T | 8 |
| 27 | T | F | F | T | 9 |
| 30 | F | T | F | T | 10 |

With the addition of a reset variable (V130) the pulse counter logic can be used to make Output 32 oscillate on for 15 minutes and off for 30 minutes.

```
T5[178,2] = NOT T5.V130
V131 = T5
V132 = (V132 XOR (^V131.V151)).V130
V151 = V131
V133 = (V133 XOR (^V132.V152)).V130
V152 = V132
V134 = (V134 XOR (^V133.V153)).V130
V153 = V133
V135 = (V135 XOR (^V134.V154)).V130
V154 = V134
V160 = ((^V132.V133.^V134.V135).^V160) + (V160.^(V132.^V133.V134))
V130 = ^(V160 XOR V161)
V161 = V160
O32 = V160
```

At startup of the controller, V160 and V161 will both be false so V130 will be set TRUE after the first pass and the pulse counter will start counting. When the state of variables V132-V135 reaches FTFT respectively, (10 counts of 3 minutes = 30 minutes), V160 will become TRUE.

V130 will then immediately be set FALSE for exactly one pass of all equations which will reset the pulse counter. V160 then remains TRUE until the state of variables V132-V134 reaches TFT respectively (15 minutes) at which point V160 will become FALSE and once again V130 will immediately become TRUE for exactly one pass of all equations and reset the counter.

Note that the logic works for all cases of the on and off times being less, equal or greater than each other.

Timer Example 5 - Long Time Delay Input Monitoring

Suppose it is necessary to detect an input condition being continually true for 15 minutes at which point an output is to turn on and remain on until the input condition has been continually false for 6 minutes.

The following equations do this with the desired input condition being I1/1S. (The input condition could actually be any expression.)

```
T5[178,2] = NOT T5.V130
V131 = T5
V132 = (V132 XOR (^V131.V151)).V130
V151 = V131
V133 = (V133 XOR (^V132.V152)).V130
V152 = V132
V134 = (V134 XOR (^V133.V153)).V130
V153 = V133
V135 = (V135 XOR (^V134.V154)).V130
V154 = V134
V136 = (V136 XOR (^V135.V155)).V130
V155 = V135
V162 = I1/1S
V160 = ((V132.^V133.V134).^V160) + (V160.^(V132.V133))
V130 = ^((^V162.^V160) + (V162.V160) + (V160 XOR V161))
V161 = V160
O32 = V160
```

The equation for V130 specifies the conditions which reset the counter. It is important that the length of the

stretch timer is a small, non-zero value, otherwise the base timer will not get reset properly when the pulse counter is reset (V130 set false). A value of 2 should always be used for the stretch delay.

The counter is continuously reset while

"V160 is false and the input condition is false"

OR while

"V160 is TRUE and the input condition is also TRUE"

and the counter is reset for exactly one pass following any transition of V160.

An alternative equation for V160 which produces the same result is

$$V160 = ((V132.V134).\wedge V160) + (V160.\wedge (V133)).$$

i.e. it is possible to leave out some of the "least significant" variables which for which the "match condition" is FALSE.

Timer Example 6 - Long Time Delay Input Monitoring

The following example of pulse counter timing is a variation of the preceding example. Suppose an output is to turn on after an input condition has been TRUE continually for 15 minutes and stay on for exactly 6 minutes and then turn off and stay off until the input condition has a transition from FALSE to TRUE and the cycle starts again.

$$T5[178,2] = \text{NOT } T5.V130$$

$$V131 = T5$$

$$V132 = (V132 \text{ XOR } (\wedge V131.V151)).V130$$

$$V151 = V131$$

$$V133 = (V133 \text{ XOR } (\wedge V132.V152)).V130$$

$$V152 = V132$$

$$V134 = (V134 \text{ XOR } (\wedge V133.V153)).V130$$

$$V153 = V133$$

$$V135 = (V135 \text{ XOR } (\wedge V134.V154)).V130$$

$$V154 = V134$$

$$V136 = (V136 \text{ XOR } (\wedge V135.V155)).V130$$

$$V155 = V135$$

$$V162 = I1/I5$$

$$V160 = ((V132.\wedge V133.V134).\wedge V160) + (V160.\wedge (V132.V133))$$

$$V163 = ((\wedge V160.V161) + V163).V162$$

$$V130 = \wedge (\wedge V162.\wedge V160) + (V160 \text{ XOR } V161) + V163$$

$$V161 = V160$$

$$O32 = V160$$

V163 is set true when V160 has a transition from TRUE to FALSE (i.e. the point at which the output turns off), and latches TRUE until V162 (the input condition) becomes FALSE.

The equation for V130 specifies the conditions which reset the counter, i.e. the counter is reset when:

"the input condition is FALSE and V160 is FALSE"

OR while

"V163 is true"

and the counter is reset for exactly one pass following any transition of V160.

Timing Accuracy

For time delays requiring greater accuracy/resolution, smaller values of the start and stretch delays in the base timer of the pulse counter can be used but more equations and variables will be needed to achieve longer times. For accuracy, it is important that the stretch delay value in the base timer is a small non zero value - the value 2 is recommended. Also, the start delay should always be a non zero value - i.e. do not have a value

of zero for the start delay.

There is an inaccuracy in the base rate of a timer. Due to the way the time is measured, the controller decrements every timer at a nominal rate of once every 1.008 seconds (1008 milliseconds) and this is also subject to a variation in the base crystal oscillator which is approximately 0.5% (half a percent).

Hence, with increasing a time delay, a variation of +1.3 percent to +.3 percent can occur. In a 24 hour period this can amount to 15 to 20 minutes.

Even with start and stretch delays both non-zero, there is potential for variation in the repeat rate of a time, e.g. T5[1,1] = NOT T5, will repeat exactly every 2 seconds in most cases except for programs where the time to execute one pass of the output logic is approaching 1 second or more.

For all but extremely large programs, the execution time of one pass of the output logic is normally less than 500 milliseconds.

If a timer is used to drive a pulse counter, any inaccuracy in the base timer has a multiplying effect through the pulse counter.

5.4 Change Log

The change log is a RECORD of changes made to an IO-Net program. When you save a file, you will be prompted to fill in a summary of the changes you have made, and this will be maintained in the Change Log.

5.5 Notes

Enter any text you like here. It is for documentation and notes on operation of the system.

This information is not stored in the IO-NET controller, so it will not be extracted when [Extracting a program from an IO-NET Controller](#)^[57]. Therefore, and as a backup, it is essential that you maintain a copy of the SmartConfig file.

5.6 Network Profiles

The network profiles for various baud rates, and with and without modems, are prepared by Johnson Controls and supplied with SmartConfig. They should not need changing or adding to by a user.

More information on the parameters is in LT0115 VIGILANT IO-NET PROGRAMMABLE CONTROLLER USER'S MANUAL.

5.7 Example Programs

Some example programs are included here.

See the next few pages (press next at the top of the page, or expand the table of contents), for more details.

5.7.1 Duplicating Non-Programmed mode

The following program duplicates the operation of non-programmed mode if it was running in a controller with address zero.

O1 = I1/1A OR I1/1S

O2 = I1/2A OR I1/2S
 : : :
 O32 = I1/32A OR I1/32S

5.7.2 Passing Data onto the IO-NET network

Each controller transmits the state of all its inputs onto the IO-NET network. By wiring a local output to one of its own inputs it is possible for a controller to effectively pass output information onto the network for use by other controllers. This could include error conditions E.g.. INF or ZNF, or perhaps even the state of one of its own outputs.

With an output wired directly to an input, when the output is on, the state of the input will be EITHER alarm or short circuit (with low current pull-up it will definitely be short circuit but with high current pull-up it may be either alarm or short circuit) and when the output is off, the state of the input will be either normal or open circuit depending on whether an EOL resistor is connected or not.

E.g.. if the controller at address 8 has output 32 wired directly to input 32 and included the statement O32 = INF OR ZNF, then if some other controller (say 5) included the statement

O1 = I8/32A OR I8/32S

then output 1 (on controller 5) would be on when controller 8 had a zone network fault (ZNF) or an IO-NET network fault (INF).

5.7.3 Accessing Zones

The following are simple examples of output logic using MX4428 / F3200 / MX1 fire panel zone data.

O1 = Z3:1A ; output 1 on if zone 3:1 is in alarm

V1 = Z0:2A OR Z0:3A OR Z0:4A

O2 = V1 ; output 2 on if alarm on zones 2, 3 or 4 of panel 0.

O3 = NA (I1/1S; Z1:2A, Z1:3A, Z1:4A)

; output 3 on if any new alarm on zones 2, 3 or 4 of panel 1, latched ; until reset by short circuit on input 1 on controller 1.

O4 = Z2:156F OR Z3:157F OR V1

; output 4 on if fault on zone 2:156 or zone 3:157 or if
 ; alarm on zones 2, 3 or 4 of panel 0 (from expression for V1 above)

5.8 Checking a Program

Use the command Check | Check Output Logic.

This checks the logic without attempting to connect to an IO-NET programmer.

You may need to adjust the amount of available RAM in the Parameters page, Off-Line RAM assumptions. See [RAM Assumptions](#) ^[39].

5.9 Programming an IO-NET Controller

To program an IO-NET controller, or check the free space for a new program, use the command File | Download to / Upload from Panel.

You will be given the following options. Apart from "Select Comms Port" they all require the IO-NET programmer, with the proposed IO-NET chip inserted, to be connected to the selected Comms port on your PC.

Note to check your program without downloading it and without being connected to an IO-NET programmer, see [Checking a Program](#)^[56].

Compile Only

This compiles your program "online". I.e. it as well as checking for syntax errors it also checks the program will fit in the connected chip.

Compile & Program Chip

This compiles your program, and if there are no errors and it will fit in the chip in the IO-NET programmer, downloads the program to the chip in the programmer.

Compile & Verify against Chip.

This compiles your program and verifies it against the contents of the chip in the IO-NET programmer.

Retrieve Space Info

This shows details of the chip in the IO-NET programmer, including the amount of free EPROM.

Extract Latest Program from Chip

This will allow you to extract the latest program from an IO-NET controller. (See [Extracting a program from an IO-NET Controller](#))^[57]

Extract Older Program from Chip

This will allow you to extract a selected program (not necessarily the latest) from an IO-NET controller. (See [Extracting a program from an IO-NET Controller](#))^[57]

Select Comms Port

This enables you to select the comms port on your PC for subsequent operations. The port you select will be remembered across SmartConfig sessions.

LEDs on Programmer Board

When your PC is reading data in the chip, both the Verified and Programming LEDs will be on. When your PC is writing data to the chip, the Programming LED (only) will be on.

5.10 Extracting a program from an IO-NET Controller

To extract a program from an IO-NET controller, use the menu command File | Upload new from Panel | IO-NET. (Or if you already have an IO-NET file open, you can use File | Download to / Upload from Panel).

Then to extract the **latest** program in the chip, click "Extract Latest Program from chip".

You can also extract an older program from the chip, one that has been replaced by a newer version. Click "Extract Older Program from chip". You will then need to enter the program number to extract, where 1 is the first program that was ever programmed into the chip, 2 was the second program that was ever programmed into the chip, and so on. You will be advised the latest program number, so if you want the second latest for example, enter a number one less than the latest.

Every program you extract will create a new MDI child window with a name such as NONAME1, NONAME2 etc. You can access these windows with the window menu.

Note - when you extract the latest program from a chip, the CRC of the program will be checked against the chip contents including the remaining free space. When you extract an older program, the CRC will be checked against the older program plus the assumed erased state for what was the remaining free space at the time. It can therefore be much quicker to extract a selected program number than the latest program (even if the selected program number is the latest).

LEDs on Programmer Board

When your PC is reading data in the chip, both the Verified and Programming LEDs will be on.

6 T-Gen2

This section contains information about using SmartConfig to program a T-Gen2 Emergency Warning System's site-specific data file.

6.1 Overview

Overview

The VIGILANT T-Gen2 is a self-contained Grade 1, 2, or 3 Emergency Warning System (EWS) with 100V speaker line supervision and digitised speech messages. It is compliant with AS 4428.16.

T-Gen2 is available in two versions for assembly directly into fire panels or other equipment:

T-Gen 60 60W unit with tones, fault supervision and speech. Has built-in storage for up to 2 minutes of pre-defined messages and tones. A microphone input is available for emergency public address and for recording messages different to the standard messages supplied. Can be configured as a slave unit to a master T-Gen2.

T-Gen 120 Same as T-Gen60 except the power output is 120W.

Optional modules that can be used with T-Gen2 are:

100V Switching Module This splits the T-Gen2's 100V output into 4 short-circuit isolated outputs that can also be used to direct paging announcements to specific areas.

T-Gen2 User Interface A 3U 19" rack door containing a Grade 2 or 3 User Interface and a microphone for controlling the T-Gen2, or making either emergency speech or area paging announcements.

14A PSE A battery charger/PSU for powering multiple T-Gen2. Up to 10 can be configured, with the battery charger enabled/disabled on each one.

HLI The FP1143 High Level Interface (HLI) module provides an electrical interface between a compatible fire panel and the T-Gen2 for RZDU or 4100 Comms protocol.

The T-Gen2 is also available as a self-contained single zone building occupant warning system (BOWS) (FP1144 and FP1134) or as an emergency warning system with up to 20 zones (FP1129 or build to order).

Related Documents

Refer to the following manuals :

- LT0667 LIT,T-Gen2 60/120 INSTALLATION & OPERATION MANUAL
- LT0668 LIT,T-Gen2 100V SWITCHING MODULE INSTALL INSTRUCTIONS
- LT0669 LIT,4100ESi, T-GEN 60/120 MTG BRKT INSTALL INSTRUCTIONS
- LT0670 LIT,4100ESi, 2 X 100V MODULE BRKT INSTALL INSTRUCTIONS
- LT0671 LIT,T-Gen2 100V SPLITTER MODULE INSTALL INSTRUCTIONS
- LT0672 LIT,GRADE 3 USER INTERFACE INSTALLATION GUIDE
- LT0673 LIT,T-Gen2 USER INTERFACE OPERATING INSTRUCTIONS
- LT0676 LIT,BOWS T-Gen2 INSTALL & OPERATING INSTRUCTIONS
- LT0681 LIT,GRADE 2 USER INTERFACE INSTALLATION GUIDE
- LT0682 LIT,T-Gen2,GRADE 2 UI OPERATING INSTRUCTIONS
- LT0683 LIT,GRADE 2 16Z EXTENDER DOOR INSTALLATION GUIDE
- LT0684 LIT,GRADE 2 8Z EXPANSION BRD INSTALLATION GUIDE
- LT0685 LIT,PSE 14A,GEAR PLATE MTD,INSTALLATION GUIDE
- LT0687 LIT,GRADE 2 BOWS INSTALL & OP INSTRUCTIONS
- LT0690 LIT,4100ESi 14A PSE BAY MTG BRKT INSTALL INSTRUCTIONS

- LT0691 LIT,T-Gen2 HLI BOARD INSTALLATION INSTRUCTIONS

Hardware / Software Requirements

Note that disabling some of the default settings may mean non-compliance with the applicable standards - e.g. AS 4428.16 or NZS 4512.

Terminology

| | |
|------------------------|--|
| Manual Mode | Where the operator controls the broadcast of emergency warning signals. |
| Automatic Mode | Where emergency warning signals are triggered by an alarm detection system and will activate without human intervention. |
| Power Save Mode | Reduced power state where background functions are disabled to prolong the life of standby batteries as the mains supply has a fault or has failed completely. |
| Area Paging | Making a voice announcement to a part of the building, known as a paging area, for non-emergency PA. |
| Area | A collection of T-Gen2 100V outputs and 100V Switching Module outputs that can be configured to broadcast audio sources or signals in non-emergency mode. Note this collection may be quite different to the zone assignment. |
| Zone | A collection of T-Gen2 100V outputs and 100V Switching Module outputs that receive the same warning signals in emergency mode. The warning signals can be manually activated via the user interface or automatically in the alarm condition. |
| Area Mapping | The configuration of which area a non-emergency signal or audio source should be broadcast to. |

6.2 Operation

The T-Gen2 can operate in two different modes:

- Non-Emergency - when no alarms, alerts, evacuate or speech conditions are present.
- Emergency - when one or more alarms, alerts, evacuate or speech conditions are present.

Non-Emergency Mode

In non-emergency mode the audio sources or signals are mapped to outputs using a concept of areas. Each T-Gen2 or 100V Switching Module output can be mapped to an area and each audio input function can be programmed to select which areas are enabled when the function is active. This allows configuring, for example, which 100V outputs should generate background music when it is enabled, or which outputs play the selected signal when User Button 1 is pressed.

Each of these inputs or buttons can be assigned an area mapping list that defines the areas to be activated when the function is selected:

- Inputs assigned to play signals
- Inputs assigned to Paging Line 1 or Paging Line 2
- Always on audio inputs
- User 1 button
- User 2 button

As an example, with the area selections and area/output mapping shown in the diagram below, background music will be played to Area 1 only - which includes the 100V Switching Module outputs 1 and 2. Whereas the User 1 signal will be played to areas 1 and 2, which includes the slave 1 T-Gen2 100V output plus all 4 Switching Module outputs.

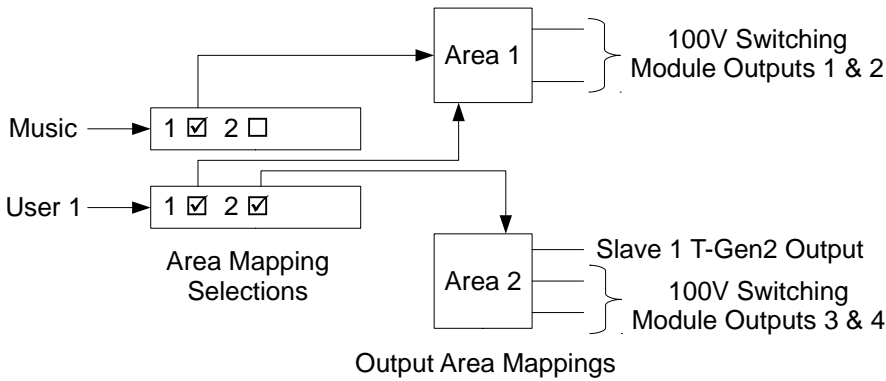

Emergency Mode

In emergency mode zones are used, not areas. Each input set as alarm trigger is mapped to a specific zone to put that zone into alarm when the input is active. Each of the T-Gen2 100V outputs, Strobe outputs and the 100V Switching Modules outputs can be assigned to a zone.

The [Cascade](#) table is used to specify how an alarm condition on each zone is used to put that zone and all the other zones into the Alert or Evacuate states. The alarm condition could put all zones into evacuate (all-out operation), or could put just the zone in alarm into evacuate, then at the end of each cascade delay put another zone into evacuate, therefore stepping through the building.

6.3 Audio Mapping

The 100V output of each T-Gen2 can be assigned to a specific zone or wired to a 100V Switching Module input which switches the 100V signal to each of its 4 separate outputs. Each 100V Switching Module actually has two 100V inputs (Inputs A & B) so that each 100V output can be switched to broadcast Input A, Input B or neither (silence). In parallel mode two 100V Switching Modules have their 100V outputs wired together, with the B input on the 2nd (Address + 1) 100V Switching Module as a third audio source. This creates a 3 way selector switch plus silence for each 100V output. To enable the master T-Gen2 to switch the correct audio source to each 100V Switching Module Output, it needs to know which T-Gen2 units (master and slaves) are wired to which of the 3 possible audio inputs on the Switching Modules. On the T-Gen2 table in SmartConfig each T-Gen2 100V output is assigned via the Audio Mapping field to a dedicated zone or be A, B, or C where:

- A - connects to the A input of the 100V Switching Modules
- B - connects to the B input of the 100V Switching Modules
- C - connects to the B input of a Address + 1 Switching Module.

For example the diagram below shows 3 T-Gen2, each configured as A, B, and C respectively, wired to two 100V Switching Modules configured in parallel mode. This allows each 100V Switching Module output to broadcast one of three audio functions, or silence. The master T-Gen2 will control the delivery of the audio functions to the outputs via the T-Gen2s and 100V Switching Modules.

The fourth T-Gen2 is directly wired to a zone output, so can broadcast any input signal.

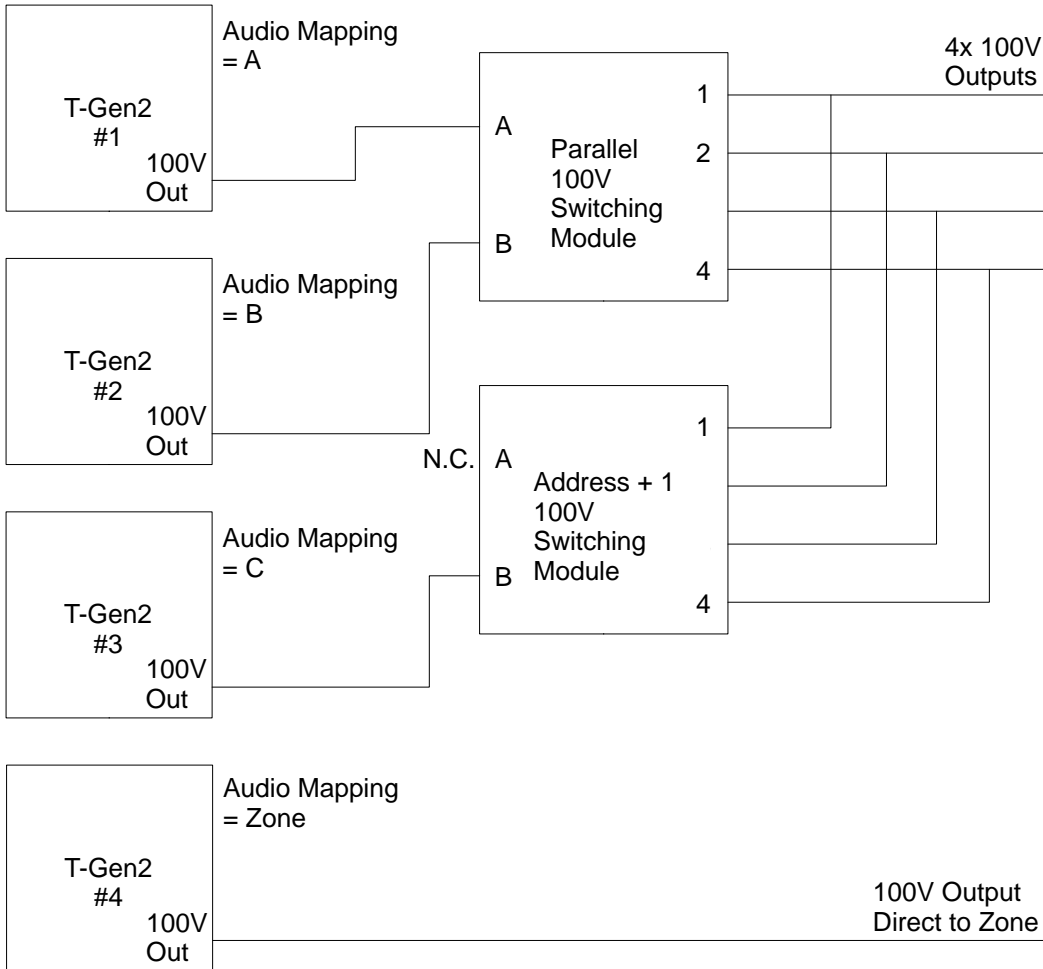

6.4 High Priority Functions

The various input and control functions are assigned a priority to determine what signals are generated when multiple conditions are present at the same time.

The default priorities are set to comply with AS4428.16, i.e., Speech (mic input) is highest, Alarm and thus Alert/Evac are next, with Input Play Message, Paging, User Buttons, etc assigned a unique priority by the user to determine what gets played.

In some special circumstances a priority may need to be assigned to an input or User button so that it overrides alarm. For example, a lockdown message needs to be assigned to a User button that must be played even if an alarm condition (and thus Alert & Evacuate) is present.

To achieve this the User Button or input with play message function is assigned a priority higher (lower number) than alarm. SmartConfig will generate a warning for this as it compromises AS4428.16 compliance. Special care needs to be taken when designing, configuring, installing and using such a high priority function.

- Activating the function will stop or not allow any alert or evacuate signal to be generated. The T Gen2 will display alarms, alert and evacuate, but the signals will not be heard.
- The high priority function will be generated in the areas it is mapped to. Any area not programmed will be silent. Therefore the function should be mapped to (almost) the whole site/building.
- If a high priority user function is active and PTT is pressed (enabling Speech which is higher priority) this will cancel the user function.
- Pressing Silence Warning button does not stop the high priority function.
- The means to activate the function must be secured, e.g. inside the locked cabinet or key activated. A

means to turn off the function should be available.

- Users must be properly trained in its use and the ramifications of its use (as people may not be evacuating when an alarm is present).

6.5 Getting Started

Start with [File | New](#)^[7]. Select the T-Gen2 panel type. Select the required template file - see [Template Files](#)^[82].

Check and adjust the settings on the [General](#)^[63], [Digital Inputs](#)^[66], [HLL Inputs](#)^[66], [Audio Inputs](#)^[68], [GP Outputs](#)^[69], [Messages](#)^[69], [Signals](#)^[70], [Strobe Sequences](#)^[71], [Switching Modules](#)^[71], [User Interface](#)^[73], [T-Gen2s](#)^[74], [PSU Slaves](#)^[75], [Cascade](#)^[75], and [Area Mapping](#)^[76] pages as required.

Save the working file, with an identifiable filename.

Run [Checks](#)^[81] on the tables. Fix any [errors](#)^[81] or [warnings](#)^[81] generated.

Download the configuration to the T-Gen2 as described in [Transfer DB to/from T-Gen2](#)^[79].

Test the configuration in the T-Gen2 system.

6.6 Tables

This section describes each of the "tables" used for T-Gen2 Configuration.

6.6.1 General

This page allows some general options to be configured.

General

System Name

Enter a name for the system. This is shown on the on-board display of the T-Gen2 when using the Software → Config File menu command.

Firmware Version

Firmware version installed in all the T-Gen2s in the system - V1 or V2+. This is a read-only field - there is no capability to upgrade an existing configuration. You must start the configuration using the correct template.

Also make sure all the T-Gen2s in the system contain this software version.

System Grade

System grade (1 to 3) as defined by AS 4428.16.

Grade 1 and 2 systems have multiple zones and a defined cascade when a zone is triggered into alarm.

Grade 3 is a single zone system.

Number of Zones

The highest zone number (1 to 20) in a Grade 1 or 2 system.

Paging Priority

The priority of paging from the Grade 3 user interface. Audio inputs selected with an Activation type of Paging have their priority set on the [Audio Inputs](#)^[68] table. Audio inputs selected with an Activation type of GP Input have their priority set on the [Digital Inputs](#)^[66] table.

Alarm State

Alert Signal

Signal played for alert in manual or automatic modes.

Evac Signal

Signal played for evacuation in manual and automatic modes.

Change Time (s)

Grade 3 only - for Grade 1 & 2 the [Cascade](#) table must be used instead.

The change over time from playing the alert signal to evacuate signal in automatic mode. If zero, the T-Gen2 will not play alert in automatic mode - but will go straight to evacuate on alarm.

Latching

If set, the T-Gen2 will not exit the Alarm State even if the Alarm Trigger signal returns to normal. The alarm will need to be cleared at the source, then the T-Gen2 reset using the Reset button on the user interface. If unticked, the T-Gen2 will turn off Alert/Evac when all alarm inputs return to normal.

Priority

The priority to play the alarm signals (Alert and Evacuate).

Fault Outputs

Enable Fault Relay

If not set, the fault relay is not used.

Output Fault on General Fault

When set, any fault will de-energise the fault relay.

Output Fault on Zone Disabled

If set, the fault relay will be de-energised when any evacuation zone is disabled.

Output Fault on Test Mode

If set, the fault relay will be de-energised when any evacuation zone is in test mode.

Output Fault on Manual Mode

If set, the fault relay will be de-energised when manual mode is selected.

Fault Supervision

Earth Fault

If set, earth fault monitoring on the T-Gen2 is active.

100V Line

If set, 100V line monitoring on the T-Gen2 is active.

Amplifier Failure

If set, amplifier monitoring on the T-Gen2 is active.

Strobe Output

If set, strobe output monitoring is active.

Power Save Mode

Triggered by Ext. Mains Fail

If set, the T-Gen2 will enter power save mode when a digital input configured for EXT Mains FLT is active.

Triggered by Ext. PSU Fault

If set, the T-Gen2 will enter power save mode when a digital input configured for EXT Power FLT is active.

Triggered by Supply Voltage Below Min

If set, the T-Gen2 will enter power save mode when the supply voltage of the T-Gen2 drops below that specified in the field V Supply Voltage Min.

V Supply Voltage Min.

Specifies the supply voltage that if lower than, power save mode will be entered if Trigger by Supply Voltage Below Min is set.

T-Gen50 Mode

100V Out V Decreases with Supply V

If set, the T-Gen2 is set up to behave like a legacy T-Gen50, in that the 100V output voltage will decrease as the supply voltage decreases. If not set the 100V output voltage is constant over the supply voltage range.

Note that the T-Gen2 will then draw a higher current as the supply voltage is decreased. Most of the specified system capacities (e.g., Maximum 100V load supported by a PSU) assume this setting is ticked, so if clearing it will be necessary to decrease the maximum load.

Volume

Overall Volume

Adjusts the output volume of the T-Gen2, can be specified as 0 to 100. Applies to all audio signals generated by the T-Gen2.

100% is full volume, and each 10% reduction is approximately a 6dB drop in line voltage.

High Level Link

Protocol

Sets whether the High Level Link from an adjacent compatible fire panel is enabled, and what protocol (4100 Comms or Vigilant RZDU) is used.

Vigilant RZDU can be used with Vigilant MX1, MX4428, and F3200. 4100 Comms can be used with Simplex 4100ES and 4100ESi panels.

In 4100 Comms mode the T-Gen2 emulates an ID-Net Slave with a number of input/output devices. Refer to LT0619 4100ESi Programming Manual for details.

Start FIP Zone / Point

For Vigilant RZDU protocol sets the base FIP zone number that is linked to HLL Input 1. Each remaining HLL Input is linked sequentially from this base zone number.

For 4100 Comms, HLL Input 1 is linked to 1 on the emulated ID-Net slave. Each following HLL Input is linked sequentially to the next device.

Reply to FIP

For Vigilant RZDU protocol, it is optional if the T-Gen2 replies to the FIP or not. Generally this is set so the

T-Gen2 sends its fault status to the panel.

RZDU / Slave Address

Set the address that the T-Gen2 uses for replies to the FIP.

For 4100 Comms this sets the ID-Net Slave address (1-127) that the T-Gen2 replies to.

For Vigilant RZDU protocol this sets the RZDU address, and is needed if FIP replies are enabled.

Test Properties

Test Tone Priority

Sets the priority of the test tone (selectable from the OLED display).

Test Tone Period (mins)

Time period for which the test tone will remain active, unless de-activated manually.

6.6.2 Digital & HLL Inputs

The Digital Inputs table allows the settings for the digital inputs on each T-Gen2 in the system to be configured.

The HLL Inputs table allows the settings for the HLL (High Level Link) inputs in the system to be configured.

The HLL from the fire alarm panel must first be enabled in the [General](#) table.

Module

Digital Inputs table: Identifier of the T-Gen2 that the digital input is on - Master or Slave <number>.

Digital Input

Digital Inputs table: Identifier of the digital input on each T-Gen2: Alarm Input, AIE Input, or GP Input 1 to 4.

HLL Inputs table: Number of the HLL zone or subpoint. For RZDU this will start from the Start FIP Zone/Point field on the General table. For 4100 Comms this will always start from subpoint 1.

Function

Configurable function of the input. The active state is short circuit.

| Name | Description |
|---|---|
| Alarm Trigger | Force the T-Gen2 to enter Alarm state. |
| AIE | (Available for Grade 3 only) Auto (Open) / Isolate (Disable - 10k?) / Evacuate (AIE - short) Input. Use of this function is not recommended. |
| Play Signal | Play the signal specified in the Signal field. |
| Paging Line 1 (Line 1 in Version 1 firmware) | Activate Audio Input 1, if it is set to GP / HLL Input. |
| Paging Line 2 (Line 2 in Version 1 firmware) | Activate Audio Input 2, if it is set to GP / HLL Input. |
| Page Area 1 | (Version 1 firmware only) Enable paging to Area 1. Enables audio input configured for Paging. |
| Page Area 2 | (Version 1 firmware only) |

| | |
|---------------|--|
| | Enable paging to Area 2. Enables audio input configured for Paging. |
| Page Area 3 | (Version 1 firmware only) Enable paging to Area 3. Enables audio input configured for Paging. |
| Page Area 4 | (Version 1 firmware only) Enable paging to Area 4. Enables audio input configured for Paging. |
| EXT Power FLT | Monitor the fault output of an external power supply. The T-Gen2 will generate an External PSU fault condition via the fault output if the input is activate. |
| EXT Mains FLT | Monitor the mains failure of an external power supply. The T-Gen2 will enter power save mode if the input is activated and power save mode is enabled for Triggered by Mains Fail. |
| EXT Audio FLT | Monitor an external Audio Fault signal. Generates a general fault if activated. Generally used to monitor an external amplifier. |

Priority

Defines the priority to play audio for the assigned audio input. Only available for input functions that play audio - Play Signal, Paging Line 1, and Paging Line 2.

In general the priority will be set lower (higher number) than the Alarm Input priority on the General Page (so alarm overrides).

However (e.g., lockdown) for special functions must override alarm it is possible to set the priority above that of alarm. This will produce a warning in SmartConfig that cannot be removed. Refer [High Priority Functions](#) for more details.

Supervised

Enables input open circuit fault supervision. An EOL resistor will need to be fitted if enabled. Not available for AIE function.

Signal

For the Play Signal function, selects the signal to play when active.

On Off Mode

For the Play Signal function, if set, then input is in push on, push off button mode. When the input receives the first pulse, the signal starts to play. On the second pulse, the signal is stopped.

Zone

For the Alarm Trigger function in Grade 1 or 2 systems this specifies the zone that is to be put into the Alarm state when the input is active.

Link 1

For the Alarm Trigger function, provides a link to the Cascade table tab for the specified zone. For the Play Signal, Paging Line 1, or Paging Line 2 functions it provides a link to the associated Area Mapping table entry.

6.6.3 Audio Inputs

Allows the settings for the two audio inputs and the speech microphone to be configured.

Audio Input

Identifier of the audio input. MIC Input, or Line Input 1 or 2 (labelled as Audio In 1 and 2 respectively on the T-Gen2 board).

Priority

Defines the priority to play audio for the input (for Line Input 1 or 2 this is only applicable when Activation is Always On / Music).

In general the priority will be set lower (higher number) than the Alarm Input priority on the General Page (so alarm overrides).

However (e.g., lockdown) for special functions must override alarm it is possible to set the priority above that of alarm. This will produce a warning in SmartConfig that cannot be removed. Refer [High Priority Functions](#) [62] for more details.

MIC Supervised

For MIC Input, enables microphone input supervision when selected.

PTT Supervised

For MIC Input, enables PTT switch input supervision when selected.

Activation

For Line Input 1 and 2, chooses how the audio line input is activated:

| Name | Description |
|-------------------|--|
| Always On / Music | The audio input is always activated, provided the assigned priority is the highest currently selected. Usually used for a background music input. |
| GP / HLL Input | The audio input is activated by a GP or HLL digital input assigned to the corresponding function Paging Line 1 or Paging Line 2 (Line 1 or Line 2 function in Version 1 firmware). The priority is determined from the digital input priority. Usually used for external paging or audio sources that need to be switched on/off by a control signal. |
| Paging | (Version 1 firmware only) The audio input is activated by any digital input that is configured as Page Area 1 to 4. Used for area paging. |

AGC On

For MIC Input, enables Automatic Gain Control for the audio input when selected.

Volume

Sets the volume for the input, 0 - 100.

100% is full volume, and each 10% reduction is approximately a 6dB drop in line voltage.

Chime Signal

Define the signal to be played before activating the audio input. Set to None, if no chime is required.

Link 1

For the Always On / Music function it provides a link to the associated Area Mapping table entry.

6.6.4 GP Outputs

Allows the settings for each general purpose output to be configured.

Only outputs on the master T-Gen2 are available.

GP Output

Number of the general purpose output (1 - 4).

Function

Selects what status will activate the output (open collector output turns on):

| Name | Description |
|---------------------|---|
| Alarm | The T-Gen2 is in alarm state. |
| Disable | The T-Gen2 is in disable state. |
| Test | The T-Gen2 is in test state. |
| Manual | The T-Gen2 is in manual mode. |
| Fault | The T-Gen2 has a fault. |
| Abnormal | The T-Gen2 is in disable, test, or manual mode, or has a fault. |
| Audio FLT | The T-Gen2 has an audio fault. |
| Power FLT | The external power supply has a fault. |
| Busy | Audio/tone is playing out the 100V output from a source that is higher priority than background 'always on' audio inputs. |
| Playing Alert | Alert signal is playing out the speaker output. |
| Playing Evac | Evacuate signal is playing out the speaker output. |
| Playing PA | Emergency PA (speech) is playing out the speaker output. |
| EXT AMP EN | For enabling an external amplifier. Activated when audio is playing out and available on the AUDIO OUT 1 output. |
| Emergency Mode | (Version 2 or later firmware) The T-Gen2 is in emergency mode. |
| None-Emergency Mode | (Version 2 or later firmware) The T-Gen2 is in non-emergency mode. |

Supervised

For GP Outputs 1 and 2, if set, enables supervision of the output. A fault will be generated if the output is not pulled above 12V when in the off state - this provides supervision of a load to a 24V supply. A fault is generated if the load is removed, wiring is open circuit, output shorted to 0V, or the supply voltage fails. Do not enable supervision on an output with a fault condition that cannot be cleared.

6.6.5 Messages

Allows importation of audio files for messages, along with the settings for each.

Most audio file types on a PC can be imported using SmartConfig. This includes MPEG-1/2/3/4, Windows Media Audio, Ogg Vorbis, Wave, AAC, FLAC, ALAC, and AIFF.

SmartConfig will resample the audio to 16 kHz, and down-mix to mono.

Import can be performed by double clicking on the File field, or through the right-click popup menu.

The popup menu options are:

| Name | Description |
|---------|--|
| Import | Imports an existing audio file to the current row. |
| Delete | Deletes the message settings and audio. |
| Play | Plays the message audio out of the PC speakers. |
| Extract | Brings up a Save As dialog and allows you to save the message audio to disk. |

The database columns/fields are:

Name

Name of the message. This is shown in the signal builder, as well as on the T-Gen2 display in the menus.

Length (mm:ss)

Shows the length of the imported audio. Format is mm:ss, where mm = minutes, ss = seconds. This is automatically calculated on importing the message.

Recordable

If set, then this message may be overwritten by recording a new one on the T-Gen2 itself. Note the length of the original recording sets the maximum length of any new recording.

Store on SD Card

If not set, this message is stored on the internal T-Gen2 storage. If set, this message is stored on the optional microSD card. Note only non-emergency messages are to be stored on the microSD card.

File

Filename of the audio when stored on internal T-Gen2 storage or on the optional microSD card. This is managed by SmartConfig and can't be changed directly by the user. It is based on the filename of the audio file originally imported, but may be modified to remove illegal characters, reduce the length, or avoid duplicates.

CRC

CRC of the audio file. Used for checking the file integrity on the T-Gen2.

6.6.6 Signals

Defines signal sequences. A signal is a sequence of messages or silence periods with programmable repetition possible.

In the default templates numerous signals are defined. These cover the tones and strobe patterns defined by standards (AS 2220.1, AS 4428.16, NZS 4512), and a school bell tone.

The [signal builder](#)^[77] can be shown by double clicking on the Name field, or through the right-click popup menu.

The popup menu options are:

| Name | Description |
|------|---|
| Edit | Shows the signal builder ^[77] to allow editing of the signal sequence. |

| | |
|--------|---------------------------------------|
| Delete | Deletes the name and signal sequence. |
|--------|---------------------------------------|

The database columns/fields are:

Name

Name of the signal.

This cell will show an error if a signal is defined, but the name is blank, or if illegal characters are included in the signal name.

Volume

Volume the signal audio will be played back at, 0 - 100.

100% is full volume, and each 10% reduction is approximately a 6dB drop in line voltage.

6.6.7 Strobe Sequences

Defines strobe sequences.

The [strobe builder](#)  can be shown by double clicking on the Name field, or through the right-click popup menu.

The popup menu options are:

| Name | Description |
|--------|---|
| Edit | Shows the strobe builder  to allow editing of the strobe sequence. |
| Delete | Deletes the name and strobe sequence. |

The database columns/fields are:

Name

Name of the strobe sequence.

This cell will show an error if a sequence is defined, but the name is blank, or illegal characters are included in the strobe name.

6.6.8 Switching Modules

Allows the settings for each 100V Switching Module to be configured.

Address

Address of the Switching Module. Must match the address selected on the module itself.

Enabled

If set, the T-Gen2 expects a 100V Switching Module to be present at this address. A fault will be generated if it is not present.

Parallel Wiring

For Grade 1 and 2, selecting this forces the next 100V Switching Module to be automatically assigned and the outputs parallel wired to this module. This allows the A and B inputs on the first 100V Switching Module and the B input on the 2nd module to act as a 4-way input selector for each output (switching between Inputs A, B, 2nd B, and silence). Each 100V Switching Module input is wired to a specific T-Gen 100V output - as specified in each of the Input Source fields.

Name

Name of the Switching Module. This is used by only SmartConfig - the T-Gen2 never displays this.

Input Source

Input sources cannot be selected with Version 1 firmware.

A

Selects the T-Gen2 whose 100V output connects to input A on the switching module. Only those T-Gen2s with an Audio Mapping of 'A' on the [T-Gen2s](#)^[74] table can be selected.

B

For Grade 1 and 2, selects the T-Gen2 whose 100V output connects to input B on the switching module. The T-Gen2s selectable depends on whether this is a parallel wired module or not. If not parallel wired then the T-Gen2s must have a 'B' audio mapping, otherwise a 'C' audio mapping, on the [T-Gen2s](#)^[74] table.

Output 1**Supervised**

If set, supervision is enabled for output 1 on the 100V Switching Module.

Area

Sets the [paging area](#)^[60] for output 1. Selections allowed are areas 1 to 20, except for Grade 3 where it is limited to 4 areas. If None is selected the output will not broadcast any paging audio. For V1 firmware only, All may be selected - the output will broadcast the audio when any area is selected.

Zone

Sets the zone for output 1.

Output 2**Supervised**

If set, supervision is enabled for output 2 on the 100V Switching Module.

Area

Sets the [paging area](#)^[60] for output 2. Selections allowed are areas 1 to 20, except for Grade 3 where it is limited to 4 areas. If None is selected the output will not broadcast any paging audio. For V1 firmware only, All may be selected - the output will broadcast the audio when any area is selected.

Zone

Sets the zone for output 2.

Output 3**Supervised**

If set, supervision is enabled for output 3 on the 100V Switching Module.

Area

Sets the [paging area](#)^[60] for output 3. Selections allowed are areas 1 to 20, except for Grade 3 where it is limited to 4 areas. If None is selected the output will not broadcast any paging audio. For V1 firmware only, All may be selected - the output will broadcast the audio when any area is selected.

Zone

Sets the zone for output 3.

Output 4

Supervised

If set, supervision is enabled for output 4 on the 100V Switching Module.

Area

Sets the [paging area](#)^[60] for output 4. Selections allowed are areas 1 to 20, except for Grade 3 where it is limited to 4 areas. If None is selected the output will not broadcast any paging audio. For V1 firmware only, All may be selected - the output will broadcast the audio when any area is selected.

Zone

Sets the zone for output 4.

6.6.9 User Interface

This page allows the optional User Interface to be configured.

User Interface

Enabled

If set, then the T-Gen2 expects that a User Interface is connected to it at the QBus Address specified. A fault will be generated if it is not present.

No other fields on this page are available unless the User Interface is enabled.

QBus Address

The QBus address that the User Interface is assigned. Currently is always 1.

Buttons Enabled

If these buttons are not enabled, then they cannot be used. In general these optional buttons should be enabled only if users are trained in their use and the function is needed to be available on the specific system.

Disable Button

If set, the Disable button on the User Interface is enabled.

Alert Button

If set, the Alert button on the User Interface is enabled.

Test Button

If set, the Test button on the User Interface is enabled.

Silence Warning Button

If set, the Silence Warning button on the User Interface is enabled.

Reset Button

If set, the Reset button on the User Interface is enabled. This will need to be enabled if the latching alarm state is used.

User Buttons

User1 Signal

Specifies the signal to be played when User1 button is pressed, using the priority set by User1 Priority. If None

is selected, the User1 button is disabled.

User1 Priority

Sets the priority of the signal that is linked to the User1 button.

In general the priority will be set lower (higher number) than the Alarm Input priority on the General Page (so alarm overrides).

However (e.g., lockdown) for special functions must override alarm it is possible to set the priority above that of alarm. This will produce a warning in SmartConfig that cannot be removed. Refer [High Priority Functions](#)^[62] for more details.

User1 Area Mapping

Links to the [Area Mapping](#)^[76] table row for the User1 button.

User2 Signal

Specifies the signal to be played when User2 button is pressed, using the priority set by User2 Priority. If None is selected, the User2 button is disabled.

User2 Priority

Sets the priority of the signal that is linked to the User2 button.

In general the priority will be set lower (higher number) than the Alarm Input priority on the General Page (so alarm overrides).

However (e.g., lockdown) for special functions must override alarm it is possible to set the priority above that of alarm. This will produce a warning in SmartConfig that cannot be removed. Refer [High Priority Functions](#)^[62] for more details.

User2 Area Mapping

Links to the [Area Mapping](#)^[76] table row for the User2 button.

Outputs Enabled

Alarm/Fault Buzzer

If set, enables the buzzer to sound on Alarm and Fault conditions. If not set, the general Alarm and Fault buzzer operation is disabled, but System Fault on the user interface will still turn on the loud buzzer. Generally this setting should be disabled if the T-Gen2 is installed in a fire panel and the fire panel buzzer is used for alarms and faults (including T-Gen2 faults).

6.6.10 T-Gen2s

Allows the settings for the the master T-Gen2 and each connected slave T-Gen2 to be configured.

Address

Address of the T-Gen2. Is either 'Master' or must match the address programmed into the T-Gen2 units configured as Slave.

Audio Mapping

If set to 'Not Present', then no T-Gen2 is assigned at this address. Master is always present - it cannot be 'Not Present'.

With Version 1 configurations 'Not Present' or 'Enabled' can be selected..

For Version 2, this field selects the audio channel A, B, or C, or the zone, that the 100V output of this T-Gen2

is connected to. If set to A, B, or C the output is wired to the 100V audio input of [100V Switching Modules](#) ^[71].

For Grade 3 only channel A is selectable.

Selecting 'Single Zone / Area' dedicates the T-Gen2 to a single zone and/or area directly - no audio channel mapping is present. No 100V Switching Module is therefore present between the audio output of the T-Gen2 and the speakers.

Note that a 100V Splitter Module can be inserted to provide 4 short-circuit isolated outputs from the T-Gen2.

Board Type

Power output capability of T-Gen2 board - 60W or 120W.

Audio Zone

For Grade 1 or 2 systems, if a T-Gen2 is dedicated to a single zone and/or area, this specifies the zone the audio output is assigned to.

Area

If a T-Gen2 is dedicated to a single zone and/or area, this specifies the area the audio output is assigned to.

Strobe Zone

This specifies the zone that the strobe output is mapped to. When the zone goes into Evac the strobe output will activate according to the strobe sequence selected. If the strobe output goes into fault the specified zone will be put into fault. If left empty the strobe output is not used (can be left unterminated).

6.6.11 PSE Slaves

Configures the PSE (Power Supply Equipment) slaves that are connected to the master T-Gen2.

Address

Address of the slave PSE.

Enabled

Set to indicate a PSE is configured at this address or not.

Battery Charging Enabled

Set to enable the battery charger on this slave PSE.

6.6.12 Cascade

Cascades are valid for Grade 1 and 2 systems.

Each Digital or HLL Input that has a function of Alarm Trigger will have a Zone specified that gets placed into alarm when the input goes active. Zones can have multiple triggers from different inputs.

For each zone that has one or more alarm triggers, a tab is shown in the cascade table, and a cascade can be defined for when that zone enters alarm.

A cascade consists of a number of stages that define the (alert and evacuate) states of all the zones. Each stage has a delay before moving onto the next stage.

An initial delay stage where every zone is inactive (neither Alert nor Evac) is not compliant for a AS 4428.16 system and will produce a warning.

In the Edit menu, Fill Two Up One Down (with Alert), Fill Two Up One Down (Evac Only), and Fill All Out (Evac

Only) commands are present. These provide pre-defined cascades that are suitable for many installations. A dialog box will appear to query whether to apply this to the cascades for all zones, or just the current zone.

Two Up One Down is where after the cascade advances one stage an additional two zones up (higher zone number) and one zone down (lower number) are put into the next alert/evacuate state. The '(with Alert)' variant puts each zone into Alert initially, then Evac for all the remaining stages after that. Whereas '(Evac Only)' places each zone into Evac initially.

All Out is where all zones are immediately put into the evacuate state in the first stage.

Each zone state can be manually edited by clicking on the cell to make it active, then clicking the down arrow that appears, and selecting 'A' for Alert, 'E' for Evac, or blank for inactive. Typing 'A', 'E', <space> / <delete> will also work.

Enter the time delay for each stage (up to 10 minutes).

6.6.13 Area Mapping

This table configures the area mappings for functions that can enable audio to be generated in the non-emergency mode.

Each of these functions may be mapped to one or more areas. The number of areas is 20 for Grade 1 or 2 systems, and 4 for Grade 3.

Module

Identifies where the area mapping is sourced from. It can be Master or Slave <number> for digital inputs. Otherwise it is HLL, Audio Input, or User Interface which all come from the master T-Gen2.

Input

Name of the input that the row configures the area mapping for.

Function

The function that the input is configured for.

Map to Area(s)

Tick-boxes for each area that the input can be mapped to. If selected, audio will be generated in that area when the input function is active and it is the highest priority.

6.6.14 Change Log

Use this table to record changes made to the T-Gen2 configuration in SmartConfig. This information is not used by T-Gen2, but is stored in internal memory.

You will be prompted to fill this in whenever you save a file. The information you enter will be visible in the "Change Log" table.

6.6.15 Instructions

The Instructions screen provides basic instructions on how to configure a site-specific configuration based on the original template file.

6.7 Strobe/Signal Builder

Overview

The strobe/signal builder (or sequence builder) is used to define strobe and signal sequences. A strobe sequence describes only the sequence the strobe output is turned on and off. Signal sequences describe the sequence of message audio and strobe sequence that are played back simultaneously.

On the left of the window the items that constitute the sequence are shown in the order they will be played by the T-Gen2. Items of the sequence that are repeated are indented within repeat blocks.

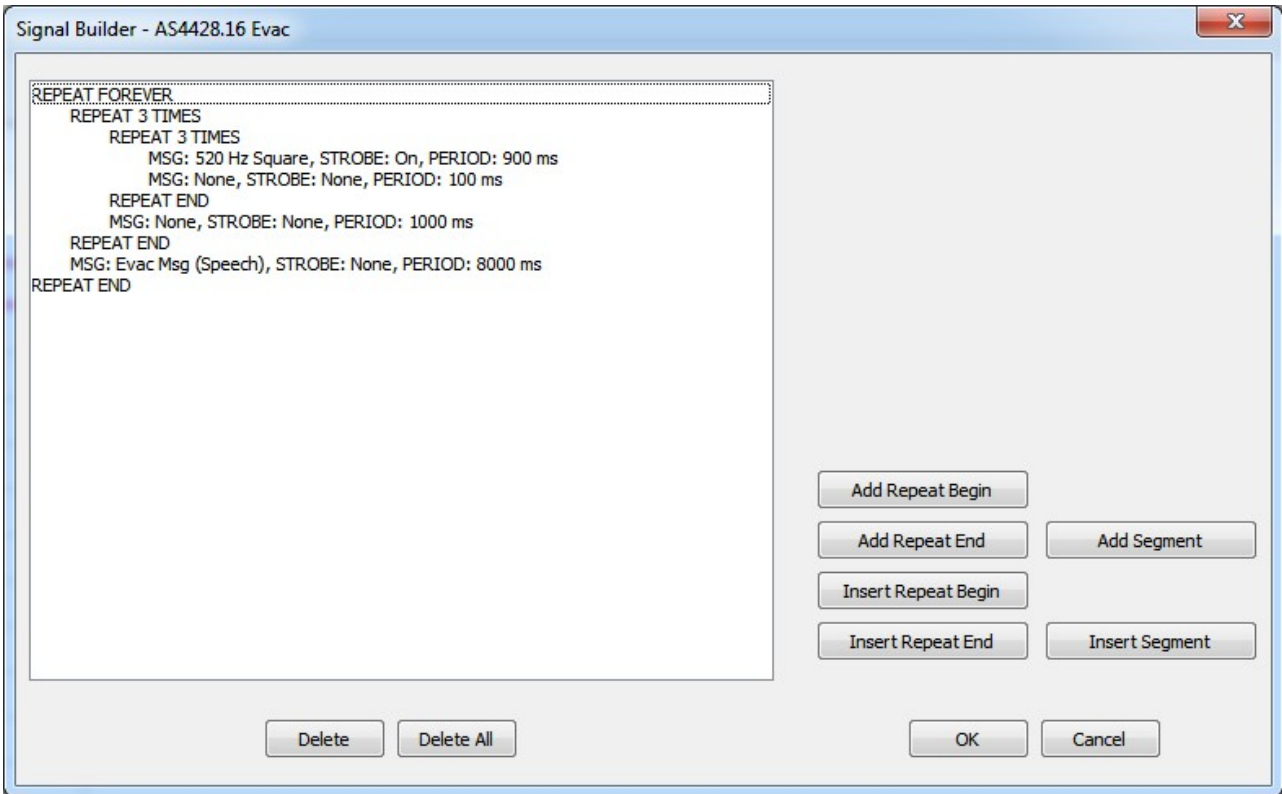

In the above example the entire contents are repeated forever (until stopped). Within this there is a 520 Hz square wave that plays for a nominal 900 ms with the strobe output on. However as the message is only 500 ms long there will be 400 ms of silence played at the end by the T-Gen2. Then there is an additional 100 ms of silence (no message selected) with the strobe output turned off. This is when the Simplex Multi-Candela strobe (4906-9103 / 4906-9104) will flash. This is repeated 3 times, followed by a 1000 ms silence, then everything including the silence is repeated 3 times. Finally an Evac speech message is played for ~5 seconds (with an additional ~3 seconds of silence).

The audible component of this signal is illustrated below:

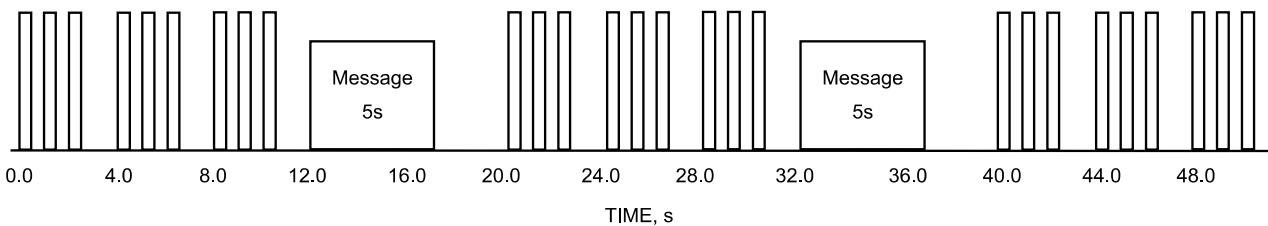

Add, Edit, Insert, and Delete Items

There is no right-click popup menu on the sequence items. To add an item use the Add ... and Insert ... buttons to the right hand side. To edit an item select it and use the edit fields to the top right hand side. To delete an item select it and press Delete. Delete All will delete all items after confirmation.

Deleting a Repeat xx item changes the indentation of the following items to reflect that they now do or don't belong to a repeat block.

The editable fields for the various items are as follows.

For Repeat Begin items it is this:

Repeat Times: 12
 Forever

The number of times the indented block is repeated can be selected as a finite number, or forever.

For Repeat End items there is nothing shown - there are no editable parameters.

For signal segment items (in the signal builder only) the editable fields are:

Message: AS2220 Alert Ramp
 Strobe: None
 Period (ms): 5636

The message, strobe, and period can be selected.

When a message is selected the Period is set to the length of the message. Afterwards the Period can then be changed to be shorter or longer. If it is longer than the message, then the additional time is filled with silence by the T-Gen2. If it is shorter, the playback of the message is truncated to the Period given.

Selecting 'None' for the message will give silence.

For strobe items (in the strobe builder only) this is the pane shown:

On Time (ms): 60000
 Off Time (ms): 0

The on time and off time for the strobe may be selected.

Repeat Begin, Repeat End, Segment (signal builder), On / Off Period (strobe builder) items all have buttons to either Add them at end of the existing sequence items, or to insert them before the currently selected item.

Items inserted after a Repeat Begin item will be indented, after a Repeat End item they will be de-indented.

Message or Strobe No Longer Exists

If a message or strobe sequence referenced by a signal segment is removed from the database after the signal

is created, an error dialog box will be shown when Check Tables or a Transfer DB to T-Gen2 is performed. The error message shown is 'Message referenced by signal segment no longer exists' or 'Strobe sequence referenced by signal segment no longer exists'.

The row of the signal with the error will be highlighted in the Signals table.

Opening the signal builder will show the signal segments with the bad references highlighted in red:

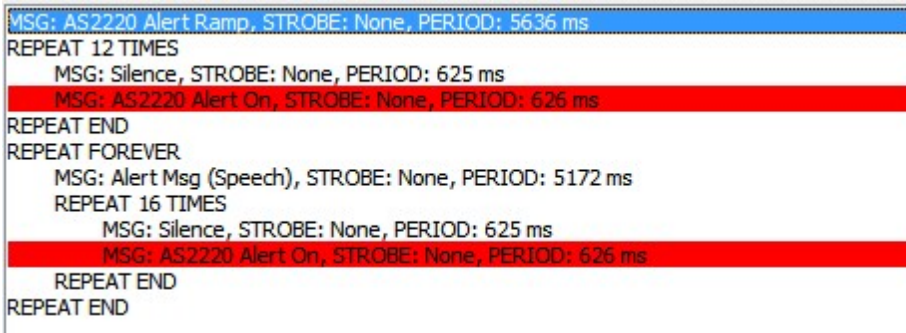

Selecting a signal segment with a bad message reference will show an error message like this:

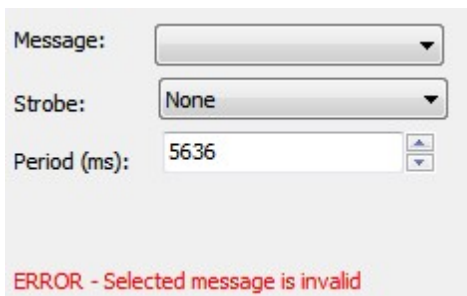

With a bad strobe reference an error message will show like this:

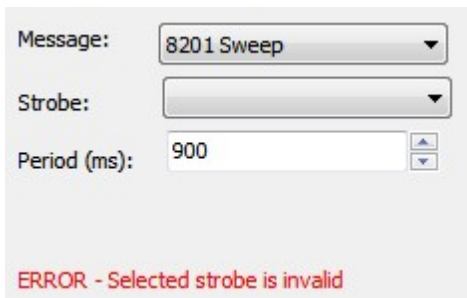

6.8 Transfer DB to/from T-Gen2

A USB to Micro-USB type cable is required. Power up the T-Gen2.

Press and hold down the BACK button. A message, 'Enable USB?', will be displayed on the T-Gen2 OLED display. Release the BACK button and press the SELECT button to allow the PC to access the T-Gen2's internal memory. The T-Gen2 will stop operating and go into fault. Plug in the USB cable to the T-Gen2 Micro-USB connector, J2.

Then in SmartConfig from the File menu select 'Transfer Selected DB Type to/from Panel', then 'Transfer T-Gen2 DB to/from Panel'. Alternatively select 'Transfer T-Gen2 DB to/from Panel' from the File menu if a

T-Gen2 database is open, or use the  button on the toolbar.

SmartConfig will then prompt whether the transfer is to or from the T-Gen2.

If the current database is not for a T-Gen2, or none is open at all, then 'Transfer from T-Gen2' is assumed.

If no T-Gen2 is not connected, or USB isn't enabled, transfer attempts will fail with a 'No T-Gen2 connected' message. If multiple T-Gen2s are connected then SmartConfig will ask you to choose between them.

When some messages in the database are stored on the microSD card, you must use a card reader attached to or integrated as part of the PC. There is no capability to use the T-Gen2 for transfers to/from the microSD card.

SmartConfig will always ask you to select the drive letter for the microSD card.

Transfer to T-Gen2

Transferring a configuration to the T-Gen2 will overwrite any existing configuration in the T-Gen2. Once done, it is not possible to recover previous configurations. SmartConfig will prompt to remove existing files if an existing configuration is stored on the T-Gen2.

If not enough free storage is available on the T-Gen2, SmartConfig will give an error message stating that the config will not fit on the storage medium.

During the transfer a progress window is shown, which may be cancelled. If a transfer to the T-Gen2 is cancelled then a warning will be shown that the T-Gen2 will be left in a non-operational state and requires reconfiguration.

When a SmartConfig prepared configuration is written to the T-Gen2, all default configurations will be deleted from the T-Gen2, to give as much storage as possible for the new configuration. The default configurations can be restored by using the [Reset T-Gen2 to Defaults](#)^[80] command.

Transfer from T-Gen2

This allows the configuration to be extracted from the T-Gen2 to the PC. During the transfer a progress window is shown, which may be cancelled. After the transfer is complete a new database with no-name is opened in SmartConfig with the contents just transferred from the T-Gen2. This can be edited, or saved.

6.9 Reset T-Gen2 to Defaults

The T-Gen2 is supplied ex-factory with a number of built-in configurations, one of which will be selected for use. It is possible to change the T-Gen2 to use one of these configurations via the push buttons and OLED display. The default configurations and selecting which to use are described in the T-Gen2 Installation & Operation Manual LT0667.

If a configuration is prepared using SmartConfig and is downloaded to the T-Gen2, then this becomes the active configuration automatically (and removes the default configurations).

To restore a T-Gen2 to the ex-factory condition (e.g., remove the SmartConfig prepared configuration) select Tools → Reset T-Gen2 to Defaults from the menu. The T-Gen2 must be prepared for the transfer in the same way as for a single database as described in [Transfer DB to/from T-Gen2](#)^[79].

This will download the built-in configurations to the T-Gen2. Once completed, it will be necessary to select which configuration is to be active - as described in LT0667.

6.10 Checks

The [Check | Check Tables](#)^[14] menu command checks all tables. The tables are also checked automatically when a file is downloaded to a T-Gen2.

The following checks are made by these commands. Those listed as "errors" will not allow the configuration to be downloaded to a T-Gen2, while "warnings" can be ignored if so desired.

Many other checks are made as data is entered, and any cells with inappropriate content are shown in red.

| Error (E) or Warning (W) | Condition |
|--------------------------|--|
| E | 'All' areas is not valid in Version 2 and above |
| E | Cell contains illegal characters: " or \ |
| E | Message has name, but no audio file imported |
| E | Message referenced by signal segment no longer exists |
| E | Messages database block too big |
| E | Signals database block too big |
| E | Strobe sequence referenced by signal segment no longer exists |
| E | Strobes database block too big |
| E | Transition to lower state in Cascade not permitted |
| W | 100V Line not supervised - AS 4428.16 compliance compromised |
| W | A digital or HLL input has Paging Line 1 function but Line Input 1 does not have GP / HLL Input activation |
| W | A digital or HLL input has Paging Line 2 function but Line Input 2 does not have GP / HLL Input activation |
| W | A line input has Paging activation, but no digital input has a Page Area function |
| W | AIE function selected for input (<module> - <input name>) |
| W | Alarm is not-latching, which is non-compliant for Grade 1 |
| W | Alarm/Fault Buzzer is not enabled, yet is mandatory for Grade 1 or 2 |
| W | Alert doesn't always transition to Evac in Zone <number> Cascade |
| W | Amplifier Failure not supervised - AS 4428.16 compliance compromised |
| W | Area(s) <list of areas> are programmed to output audio/messages but no T-Gen2 or 100V switching module output is assigned to those area(s) |
| W | Both line inputs 1 & 2 have Paging activation |
| W | Delay stages in Zone <number> Cascade are not compliant for a AS 4428.16 system |
| W | Digital/HLL inputs or line 1/2 inputs higher priority than MIC - AS 4428.16 compliance compromised |
| W | Digital/HLL inputs or line 1/2 inputs higher priority than alarm - AS 4428.16 compliance compromised |
| W | Earth Fault not supervised - AS 4428.16 compliance compromised |
| W | Fault relay is disabled - AS 4428.16 compliance compromised |

| | |
|---|---|
| W | <function> on <module>, <input> does not map to any areas |
| W | Input (<module> - <input name>) set to alarm trigger, but is not supervised - AS 4428.16 compliance compromised |
| W | Line input 1 has GP / HLL Input activation, but no digital or HLL input has Paging Line 1 function |
| W | Line input 2 has GP / HLL Input activation, but no digital or HLL input has Paging Line 2 function |
| W | MIC input is not supervised - AS 4428.16 compliance compromised |
| W | Message <name> stored on SD card but used in selected alert signal |
| W | Message <name> stored on SD card but used in selected evac signal |
| W | No fault output on general fault - AS 4428.16 compliance compromised |
| W | Priority <number> used multiple times |
| W | Reset Button is not enabled, yet is mandatory for Grade 1 |
| W | Silence Warning Button is not enabled, yet is mandatory for Grade 1 |
| W | Strobe Output not supervised - AS 4428.16 compliance compromised |
| W | Switch module <number> output <number> is not supervised, but is in use (assigned to area and/or zone) - AS 4428.16 compliance compromised |
| W | Switching modules are present, but no T-Gen2s have audio mapping A |
| W | T-Gen2 at address <number> has Single Zone / Area mapping, but no audio zone specified |
| W | T-Gen2 or 100V switching module outputs are assigned to area(s) <list of areas> but those area(s) are not programmed to output audio/messages |
| W | T-Gen2s at address(es) <list> are mapped to an audio channel (A, B, C), but are not configured as an input source to any switching modules |
| W | There are Alert to Evac transitions taking over 10 minutes in Zone <number> Cascade (not compliant with AS 4418.16) |
| W | There are T-Gen2s with audio mapping A, but no switching modules are present |
| W | User Interface is not enabled, yet is mandatory for Grade 1 or 2 |
| W | User<1/2> button higher priority than alarm - AS 4428.16 compliance compromised |
| W | User<1/2> button higher priority than MIC - AS 4428.16 compliance compromised |

6.11 Template Files

The T-Gen2 is supplied ex-factory with a number of configurations built-in. Apart from Slave and Isol. Amp, the configurations are also available in SmartConfig as templates to start a specific configuration from. When a new T-Gen2 configuration is started, the list of available templates is shown and one must be chosen. The currently available templates are as follows.

Templates for Version 2 Firmware

| Filename | Display Name | Grade | Description |
|-----------|--------------|-------|---|
| 3U_AS2220 | 3U_AS2220 | 3 | Suitable for an FP1121 3U door, or FP1122 or FP1123 doors connected to T-Gen2. Same as AS2220 but with a Grade 3 User Interface and supervised PA microphone input. |
| 3U_AS4428 | 3U_AS4428 | 3 | Suitable for an FP1121 3U door, or FP1122 or FP1123 doors connected to T-Gen2. Same as AS4428 but with a Grade 3 User |

| | | | |
|---------------|---------------|---|---|
| | | | Interface and supervised PA microphone input. |
| 4100ESi | 4100ESi | 3 | Same as AS4428 except the ALM input is unsupervised to support wiring to a NAC output on the 4100ESi APS. |
| AS2220 | AS2220 | 3 | Same as AS4428 except the Alert and Evac tones are AS 2220.1 (NZS 4512) compliant, and the Alert signal contains no speech message. |
| AS4428 | AS4428 | 3 | Suitable for a T-Gen2 installed in a fire panel without any optional modules (i.e., speech microphone, 100V Switching Modules, User Interfaces, Slaves, or PSEs). Has AS 4428.16 Alert & Evac tones, non-latching supervised Alarm input generates Evac tone and message, unsupervised AIE input plays Alert tone and message, no earth fault or Microphone supervision (it is expected the fire panel does the earth fault monitoring), Audio Input 1 is always on, and Audio Input 2 is enabled by GP Input 1. A microphone may be connected, but it is unsupervised. |
| BOWS_AS2220 | BOWS_AS2220 | 3 | Suitable for use in a Building Occupant Warning System (BOWS) - FP1134 or FP1144. Includes a user interface, speech microphone (supervised), PSE with battery charging enabled, supervised non-latching Alarm input generates AS 2220 Evac tone and message, earth fault monitoring enabled, Audio Input 1 is always enabled, Input 2 is activated by GP Input 1. |
| BOWS_AS4428 | BOWS_AS4428 | 3 | Suitable for use in a Building Occupant Warning System (BOWS) - FP1134 or FP1144. Includes a user interface, speech microphone (supervised), PSE with battery charging enabled, supervised non-latching Alarm input generates AS 4428.16 Evac tone and message, earth fault monitoring enabled, Audio Input 1 is always enabled, Input 2 is activated by GP Input 1. |
| FP1129_Grade2 | FP1129_Grade2 | 2 | Four zone, Grade 2, emergency warning system as supplied in FP1129. Includes a 4 Zone Grade 2 User Interface, PSE with battery charging enabled, and one 100V Switching Module. |

Templates for Version 1 Firmware

| Filename | Display Name | Grade | Description |
|------------|--------------|-------|--|
| V1_4100ESi | 4100ESi | 3 | Same as AS4428 except the ALM input is unsupervised to support wiring to a NAC output on the 4100ESi APS. |
| V1_AS2220 | AS2220 | 3 | Same as AS4428 except the Alert and Evac tones are AS 2220.1 (NZS 4512) compliant, and the Alert signal contains no speech message. |
| V1_AS4428 | AS4428 | 3 | Suitable for a T-Gen2 installed in a fire panel without any optional modules (i.e., speech microphone, 100V Switching Modules, User Interfaces, or Slaves). Has AS 4428.16 Alert & Evac tones, non-latching supervised Alarm input generates Evac tone and message, unsupervised AIE input plays Alert tone and message, no earth fault or Microphone supervision (it is expected the fire panel does the earth fault monitoring), Audio Input 1 is always on, and Audio Input 2 is enabled by GP Input 1. |

| | | | |
|-----------|--------|---|---|
| V1_BOWS | BOWS | 3 | Suitable for use in a Building Occupant Warning System (BOWS) - FP1136 or FP1137. Includes a user interface, speech microphone (supervised), supervised non-latching Alarm input generates AS 4428.16 Evac tone and message, earth fault monitoring enabled, Audio Input 1 is always enabled, Input 2 is activated by GP Input 1 and AIE is an Ext PSU Flt input (wired to the Charger Fault output). |
| V1_FP1121 | FP1121 | 3 | Suitable for an FP1121 3U door, or FP1122 or FP1123 doors connected to T-Gen2. Same as BOWS except Earth fault monitoring is disabled (as unit will be installed in a fire panel that has earth fault monitoring) and unsupervised AIE input will play Alert tone and message. |

Default Configurations

These configurations are only available to be selected as default configurations via push buttons and the OLED. They are not available as templates. Use the [Reset T-Gen2 to Defaults](#) [80] command to transfer the default configurations to the T-Gen2.

| Display Name | Grade | Description |
|--------------|--------|---|
| Slave | 2 or 3 | Use for a slave T-Gen2. Has supervised 100V & Strobe outputs, all inputs disabled (enable in the master T-Gen2 configuration). |
| ISOL AMP | N/A | Specific configuration for use in the FP1135 Isolation Amplifier. Select on a T-Gen2 being used as a replacement in this product. |

6.12 Firmware Update

Obtain the new firmware file for T-Gen2 from the Fireplace located at www.vigilant-fire.com.au .

Power up T-Gen2 while holding down the BACK and NEXT buttons. It will enter TGEN2 Boot Mode as shown on the OLED. On V2.00 Boot Mode and higher the word "Ready" is replaced by the version number of the Boot Mode firmware. The T-Gen2 will remain in Boot Mode for two minutes, so complete the following process quickly.



Also, the T-Gen2 will automatically enter Boot Mode on start up, if it does not have a valid firmware file contained in its flash memory.

Connect the PC Micro-USB lead to the T-Gen2 USB connector J2. On the PC a new removable disk drive should automatically be created with a name of TGEN2 BOOT.

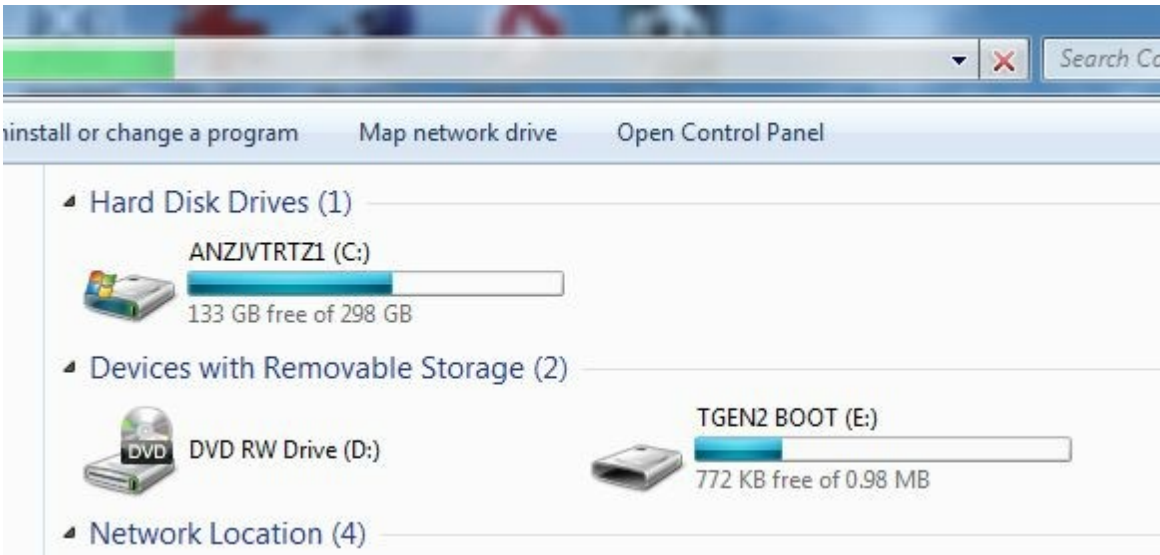

Open this up and delete the existing .bin file that is present. This will remove the old firmware from T-Gen2.

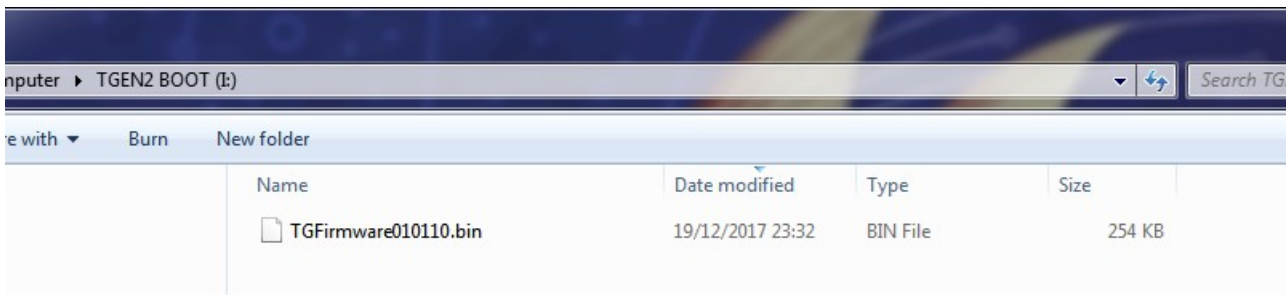

Copy (drag and drop) the new firmware file onto the TGEN2 BOOT drive. This will be written to the T-Gen2's flash memory and when completed the T-Gen2 will automatically restart using the new firmware. Check the new firmware version is correct in the T-Gen2.

If the Windows folder closes immediately the new firmware file is copied (dropped) into it, then the file is not compatible with T-Gen2 and the process needs to be repeated with the correct file.

If downgrading to a previous version (e.g. to V1.xx from V2.xx) it will be necessary to re-format the internal memory using the Diagnostics -> Format Disk command after the earlier software is installed.

Erase Firmware & USB Interface

With V2.00 Boot Mode onwards it is possible to erase the application firmware and reinitialise the USB FAT storage. This can be done if the T-Gen2 does not correctly create a T-Gen2 boot drive on the PC USB interface. While in Boot Mode press and hold the PREV button for at least 3 seconds. This will erase the application firmware and USB FAT table, and restart the T-Gen2. As no application will be present the T-Gen2 will stay in Boot Mode and display No Valid App. New firmware will need to be installed.

7 What's New

7.1 Version 2.9.0

SmartConfig Version 2.9.0 has the following new features and bug-fixes -

General

- Fix issue with voltage fields on Windows where decimal separator is configured as a comma.
- Fix issue where no template files may be shown on Windows with non-English character set.

MX1 Specific

- MX1 V1.80 database support and firmware included.
- Add support for P80AVR, P80AVW, P80AVB, P81AVB MX VADs.
- Add support for P80SB MX base sounder.
- Add profile pages for VADs and sounder bases.
- A number of invalid logic checks have been improved.

7.2 Version 2.8.0

SmartConfig Version 2.8.0 has the following new features and bug-fixes -

General

- Default passwords removed, and minimum [password strength](#)^[21] checking introduced.

T-Gen2 Specific

- Support for the T-Gen2 using version 2 firmware added - this includes support for Grade 1 & 2 systems.

7.3 Version 2.7.0

SmartConfig Version 2.7.0 has the following new features and bug-fixes -

T-Gen2 Specific

- Support for the T-Gen2 product added.

Index

- A -

About 15
 Accessing Zones 56
 ADDR 36
 Address 36
 Advanced Mode 12
 Allow reduced RAM 38
 Ancil Config (FP1600) 29
 Ancil Map Variables (FP1600) 30
 Area Mapping (T-Gen2) 76
 As Form 12
 As Table 12
 Audio Inputs (T-Gen2) 68
 Audio Mapping (T-Gen2) 61

- B -

Back 12

- C -

Cascade (T-Gen2) 75
 Change Log (FP1600) 32
 Change Log (T-Gen2) 76
 Check 14
 Check O/P Logic 14
 Check Tables 14
 Checking a Program 56
 Checks (FP1600) 34
 Checks (T-Gen2) 81
 Close 7
 Comments (FP1600) 32
 Communicating with the FP1600 Panel 32
 Compare 7
 Compile & Program Chip 57
 Compile & Verify against Chip 57
 Compile Only 57
 Constants 49
 Copy 10
 Copy with Header Row & Fixed Cols 10

CRC 14

Cut 10

- D -

Database Converter 15
 Default Folder for Load / Save 7
 Delete 10
 Digital Inputs (T-Gen2) 66
 Download (T-Gen2) 79
 Download to / Upload from Panel (FP1600) 32
 Duplicating Non-programmed mode 55

- E -

Edit 10
 Edit Cell 10
 Erase Firmware & USB Interface 85
 Example Programs 55
 Exit 7
 Export 7
 Extract Latest Program from Chip 57
 Extract Older Program from Chip 57
 Extracting a program from an IO-NET Controller 57

- F -

F3200 / MX4428 Zone Data 44
 File 7
 Fill Down 10
 Fill Series 10
 Filter... 12
 Find 12, 16
 Find Next 12
 Firmware Update (T-Gen2) 84
 Firmware, Programming 15
 Form View 17
 FP1600 Getting Started 24

- G -

General (T-Gen2) 63
 General Editing Instructions 16
 General Format 39
 Getting Started (FP1600) 24
 Getting Started (T-Gen2) 63

Go to Related Table 12
 GP Outputs (T-Gen2) 69
 Group Config (FP1600) 28
 Group Map Ancil (FP1600) 28
 Group Map Variables (FP1600) 29

- H -

Help 15
 HLL Inputs (T-Gen2) 66

- I -

Instructions (T-Gen2) 76
 IO-NET Board Inputs 44
 IO-NET Board Outputs 44

- K -

Keyboard Shortcuts 16

- L -

LCD Protocol 37
 LED Protocol 37
 LEDs on Programmer board 57
 Loading Files 35

- M -

Max Stations 36
 Messages (T-Gen2) 69
 Move Column Left 12
 Move Column Right 12
 MRAM 38
 MXST 36

- N -

New 7
 New Alarm Function 46
 Next 16
 Notes 55
 Notes column in tables 18

- O -

Open 7
 Operand Types 43
 Operation (T-Gen2) 60
 Operators 41
 Order of Evaluation 42
 Output Logic 39
 Overview (FP1600) 22
 Overview (T-Gen2) 59

- P -

Passing data onto the IO-NET network 56
 Password Strength 21
 Paste 10
 PDF 7
 Previous 16
 Print All 7
 Print Table 7
 Program Firmware 15
 Programming an IO-NET Controller 57
 PSE Slaves (T-Gen2) 75

- Q -

Quick Start 12

- R -

Reset T-Gen2 to Defaults (T-Gen2) 80
 Retrieve Space Info 57
 RZDP 37
 RZDU 36
 RZDU Number 36
 RZDU Protocol 37

- S -

Save 7
 Select 12
 Select All 10
 Select Comms Port 57
 Shortcuts 16
 Show All Rows/Unsort 12

Show CRC 14
Show Used Rows 12
Signals (T-Gen2) 70
Slave T-Gen2s (T-Gen2) 74
SmartConfig Help 15
Sort Ascending 12
Sort Descending 12
Status Display 16
Strobe Sequences (T-Gen2) 71
Strobe/Signal Builder (T-Gen2) 77
Switching Modules (T-Gen2) 71
System Conditions 47
System Config (FP1600) 31

- T -

Table view 16
Template Files 18
Template Files (T-Gen2) 82
Terminal Window (File Menu) 7
Terminal Window (General) 18
T-Gen2s (T-Gen2) 74
Timers 49
Tools 15
Transfer DB to/from panel 9
Transfer Selected DB type to/from panel 9
Transfer to / from T-Gen2 (T-Gen2) 79
TX Zone Data 37
TXZD 37

- U -

Undo 10
Upload (T-Gen2) 79
User Interface (T-Gen2) 73

- V -

Variables 45
Variables Notes (FP1600) 31
Version (FP1600) 23
View 12

- W -

What's New 86

Window 14

- Z -

Zone Data 44
Zone Map Ancil (FP1600) 26
Zone Map Groups (FP1600) 26
Zone Map Variables (FP1600) 27
Zones (FP1600) 25